

**Anbauanleitung Zusatzkit Seilwindenanbausatz
Mercedes Sprinter/ VW Crafter Bj.06 bis 12/12.**

Zu verwenden in Verbindung mit Seilwindenanbausatz 16- 60120
*Installation manual extension kit Mercedes Sprinter/VW Crafter 2006 –
Dec.2012 to use in combination with mounting kit 16-60120*

Best.-Nr.: 16-60121

AL: 2038-01



**Hier sehen sie den fertig montierten Seilwindenanbausatz.
Bevor sie mit der Montage beginnen, lesen sie bitte diese Anleitung
und das Benutzerhandbuch der Seilwinde gut durch.**

Achtung:

Bei Fahrten im öffentlichen Straßenverkehr muß das Rollenseilfenster mit einer Kunststoffabdeckung abgedeckt werden.

*Before you start fitting, please read and understand this instruction manual
and the owners manual of the winch.*

Stückliste

Zusatzkit 16-60121 Mercedes Sprinter und VW Crafter Bj.06 bis12/12

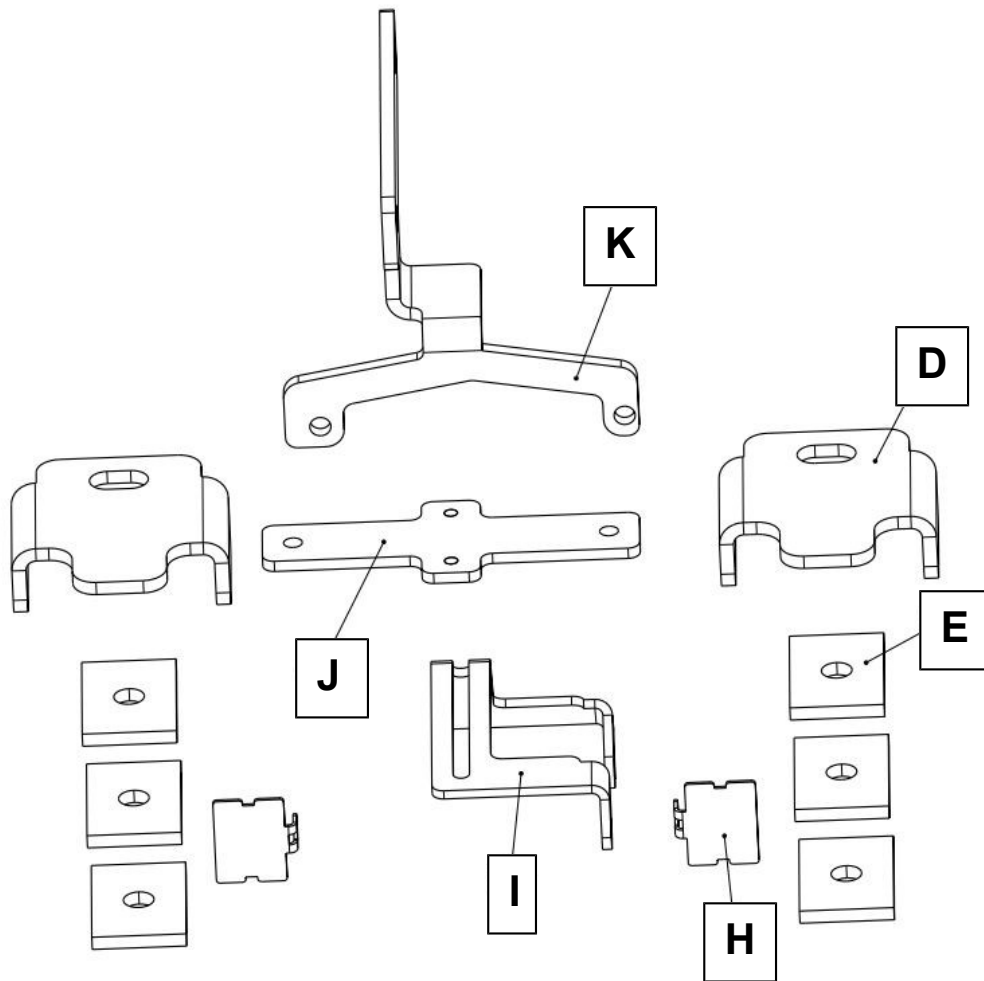

2 x Klemmstück (D)

6 x Distanzplatte (E)

2 x Kabelhalter (H)

1 x Schaltkastenhalter (VW Crafter) (I)

1 x Schaltkastenadapter XDC (J)

1 x Schaltkastenhalter (MB Sprinter m.XDC) (K)

1 x Anleitung AL 2038

2 x Schraube M 12 x 180

4 x U – Scheibe M 12

2 x Federring M 12

2 x Mutter M 12

2x Schraube M 6 x 12

4x Schraube M 6 x 20

2 x Mutter M 6

4 x Federring M 6

6 x U -Scheibe M 6 x 20

2 x U –Scheibe M 6 x30

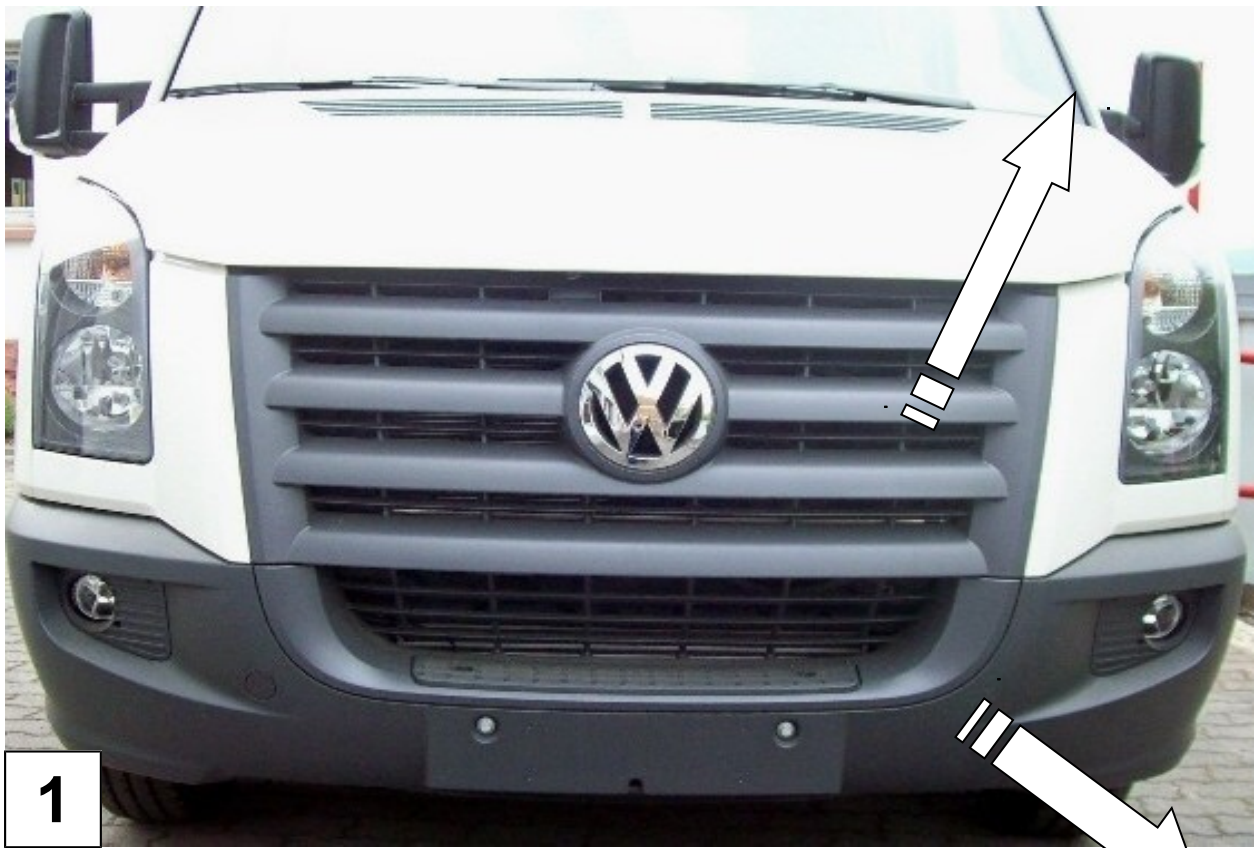



3

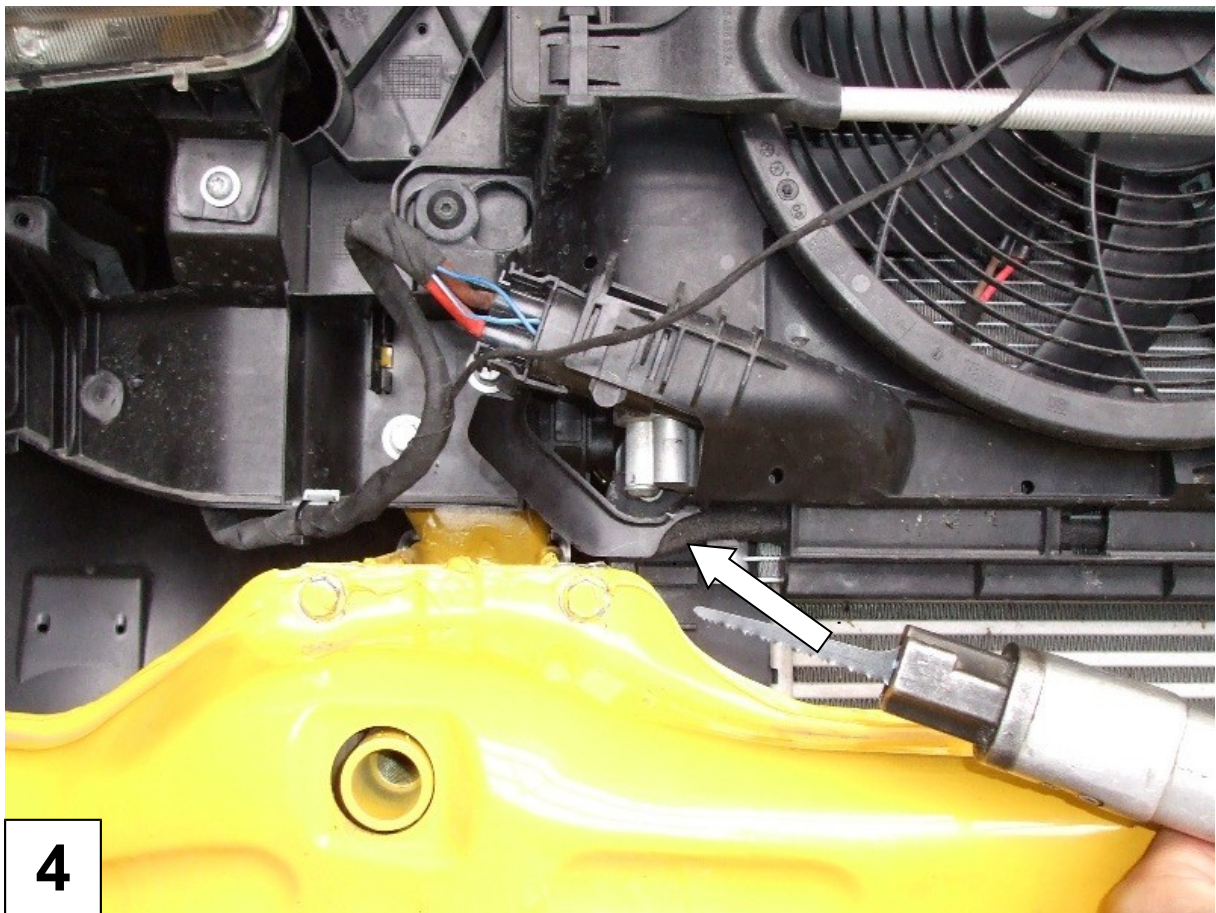

4

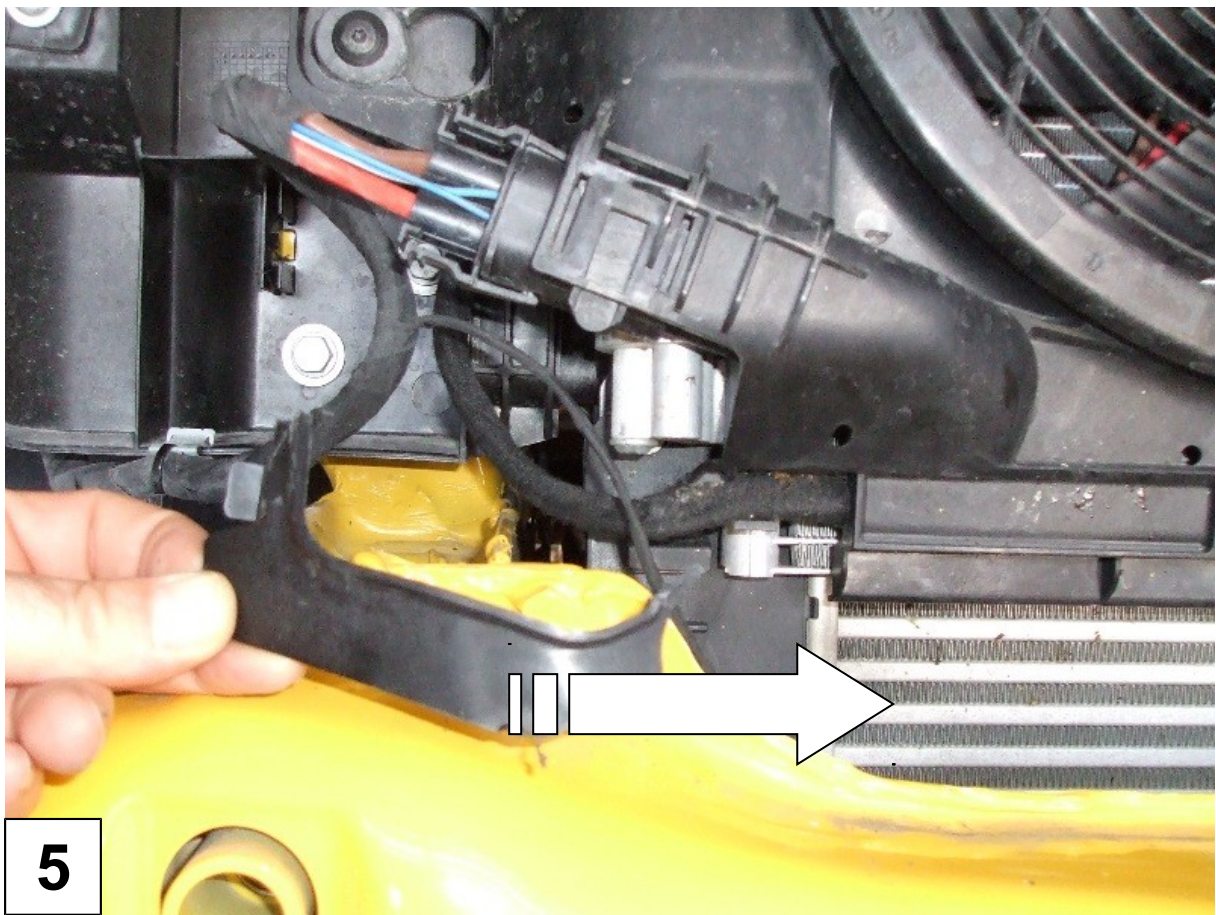

5

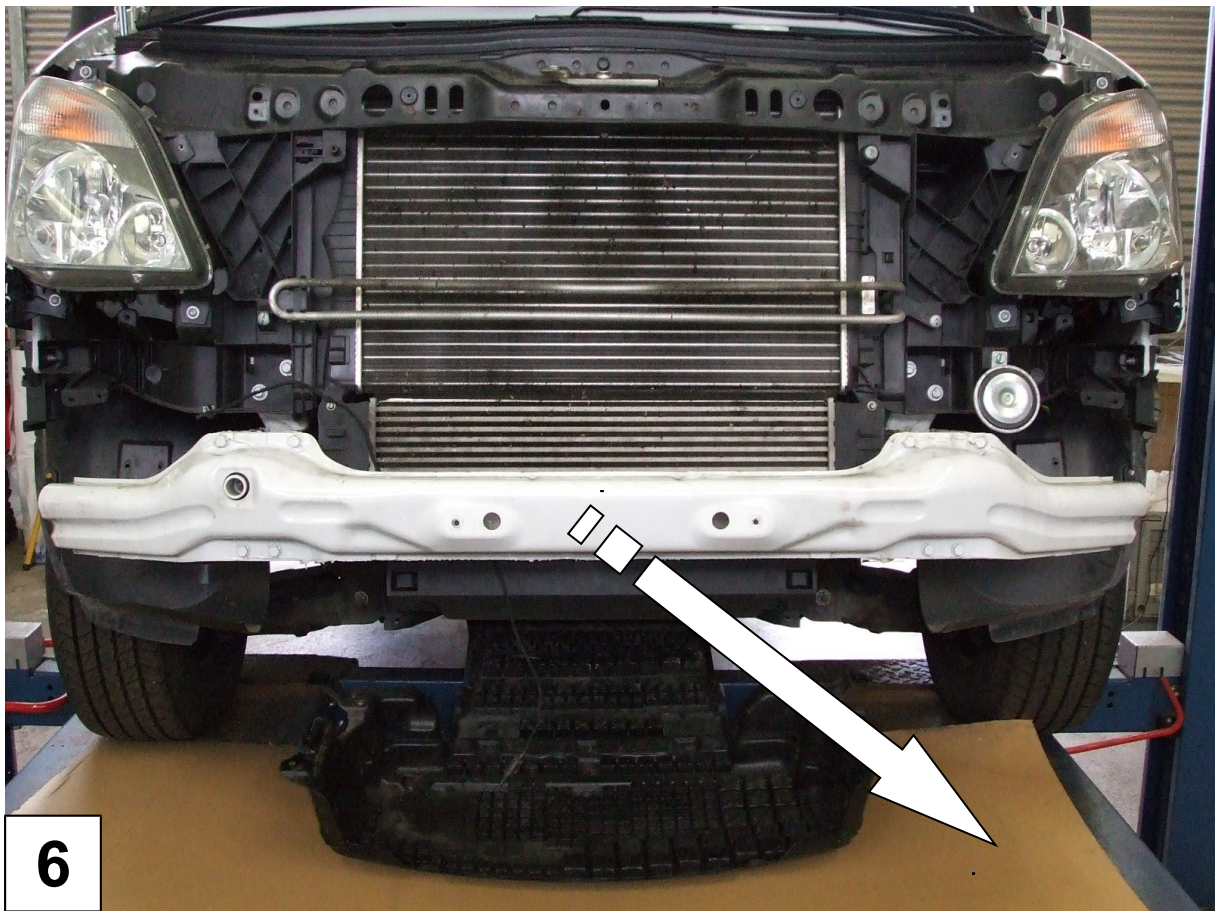

6

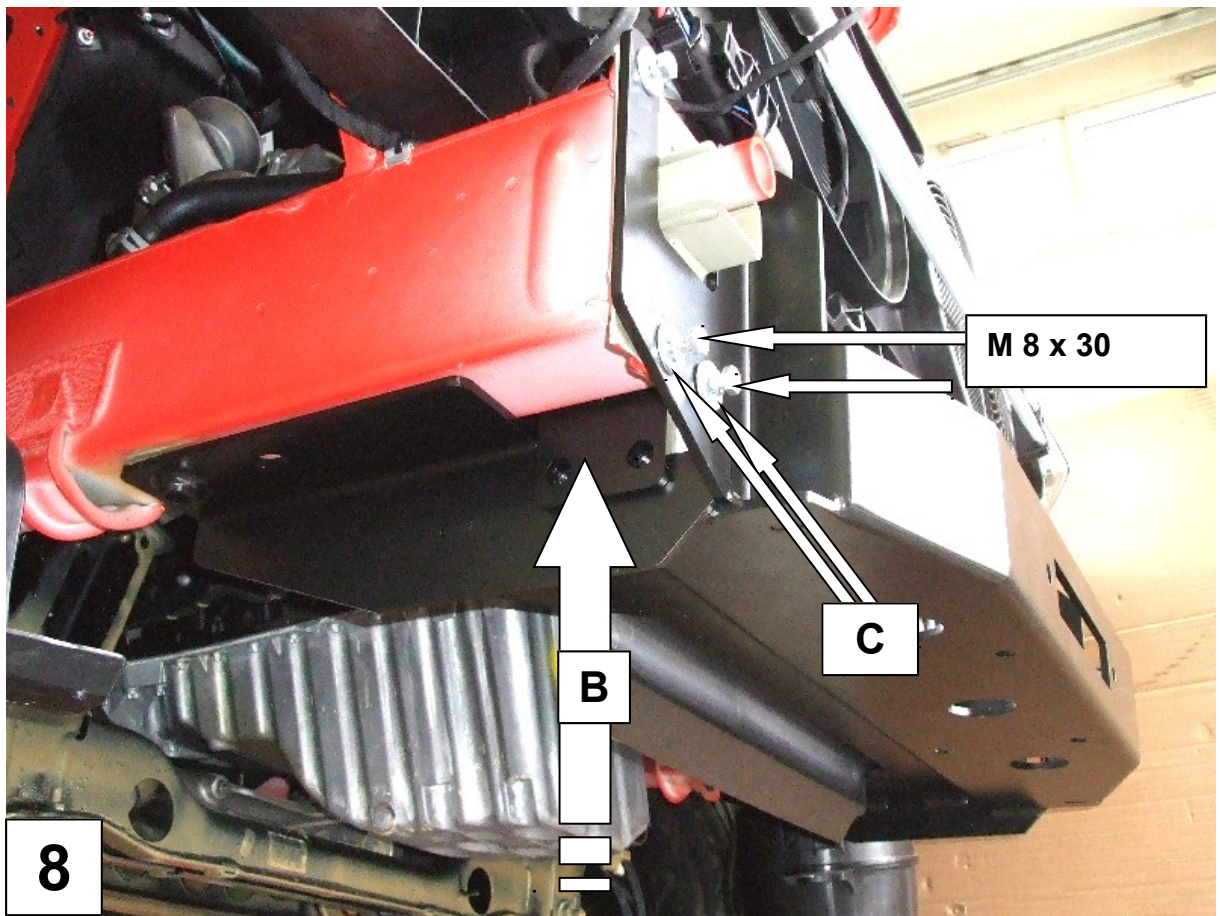
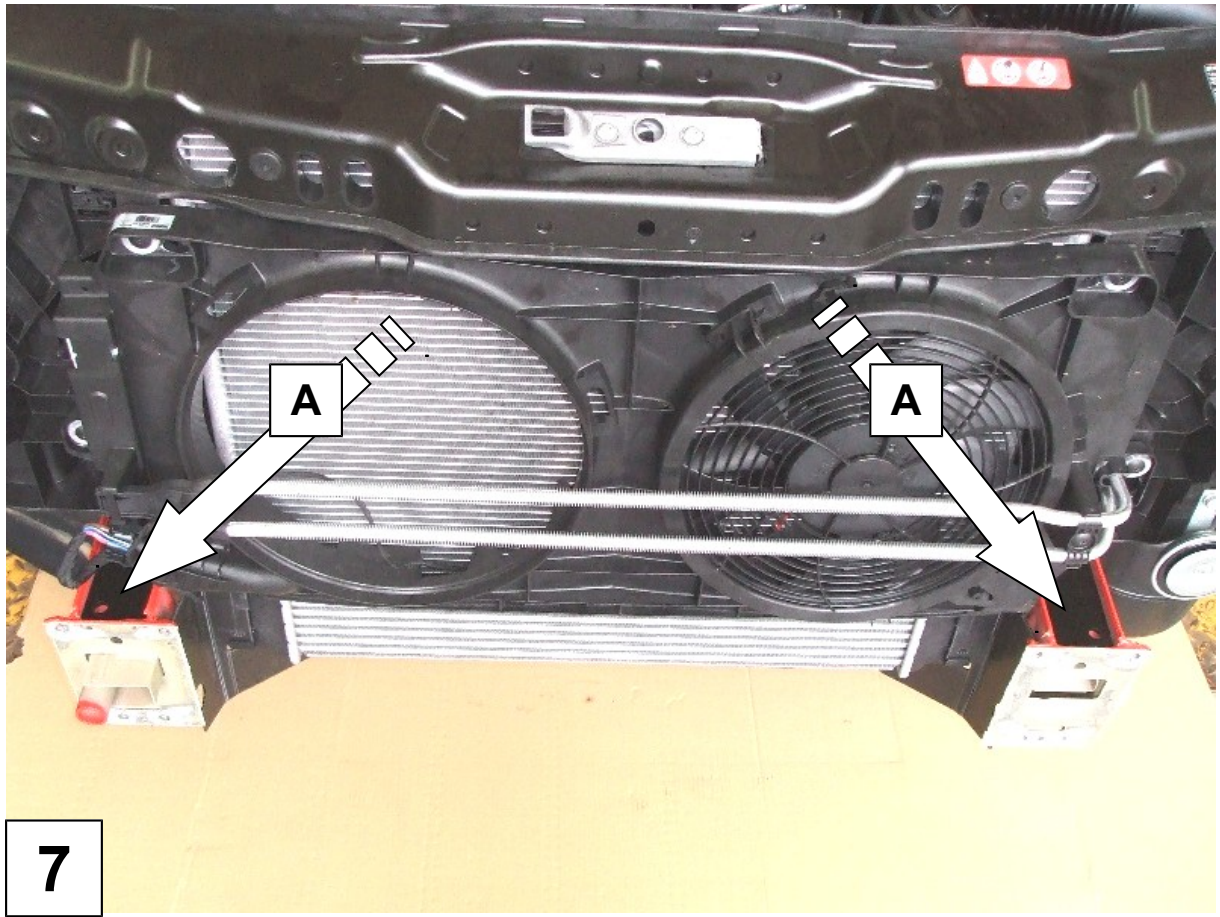

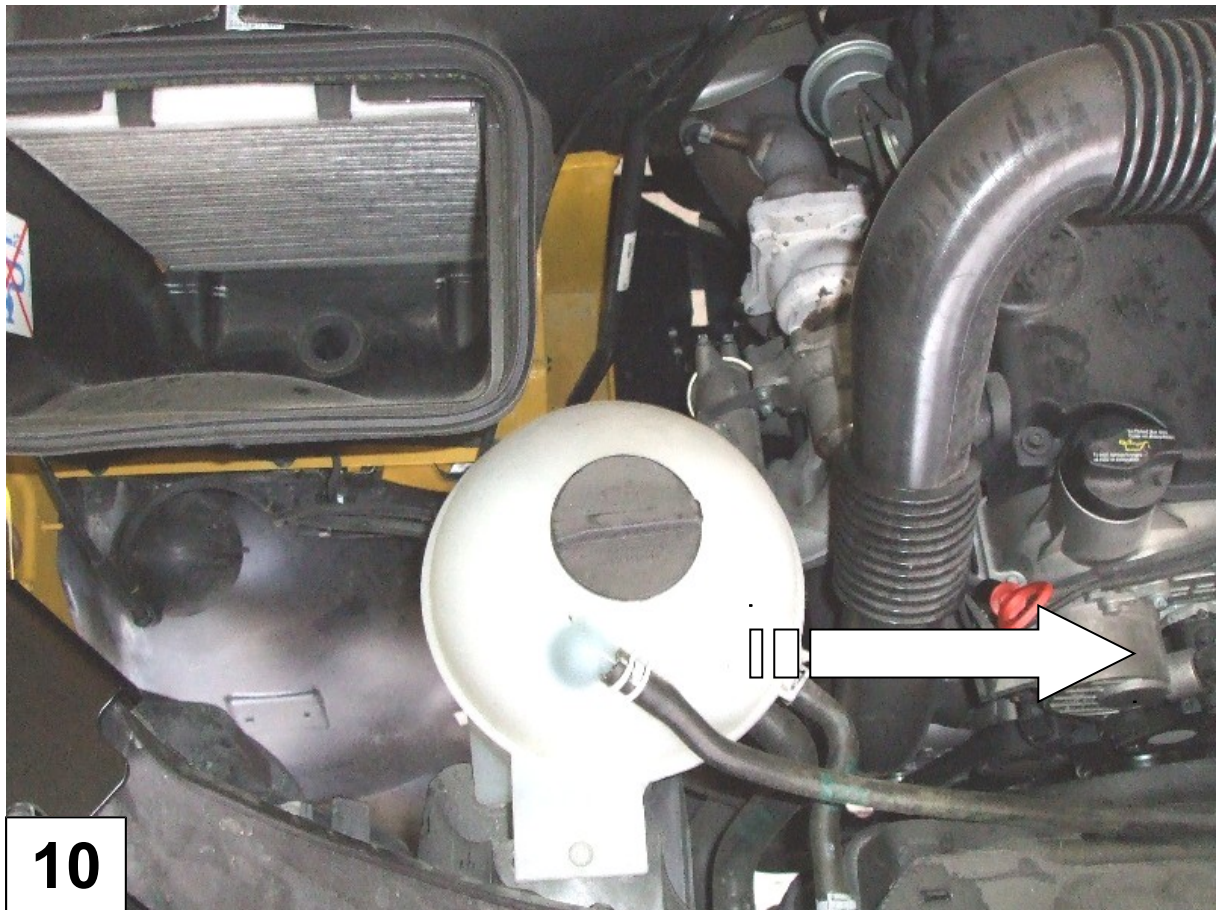
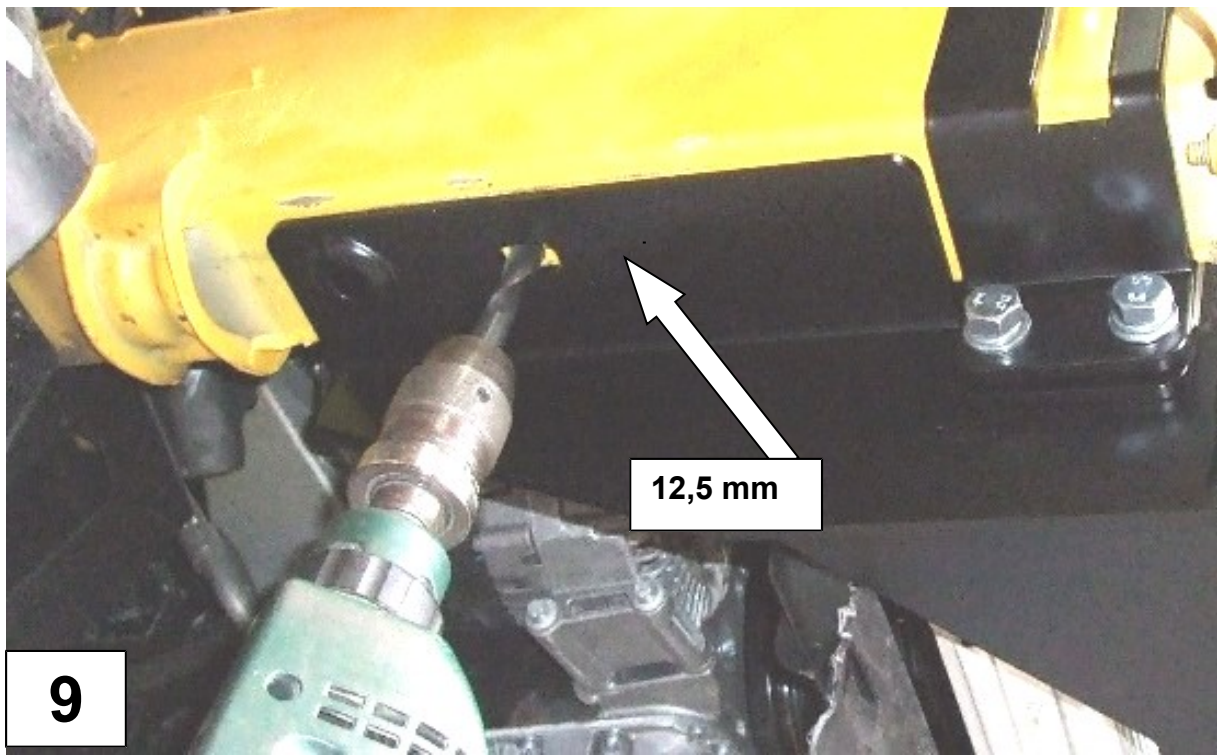

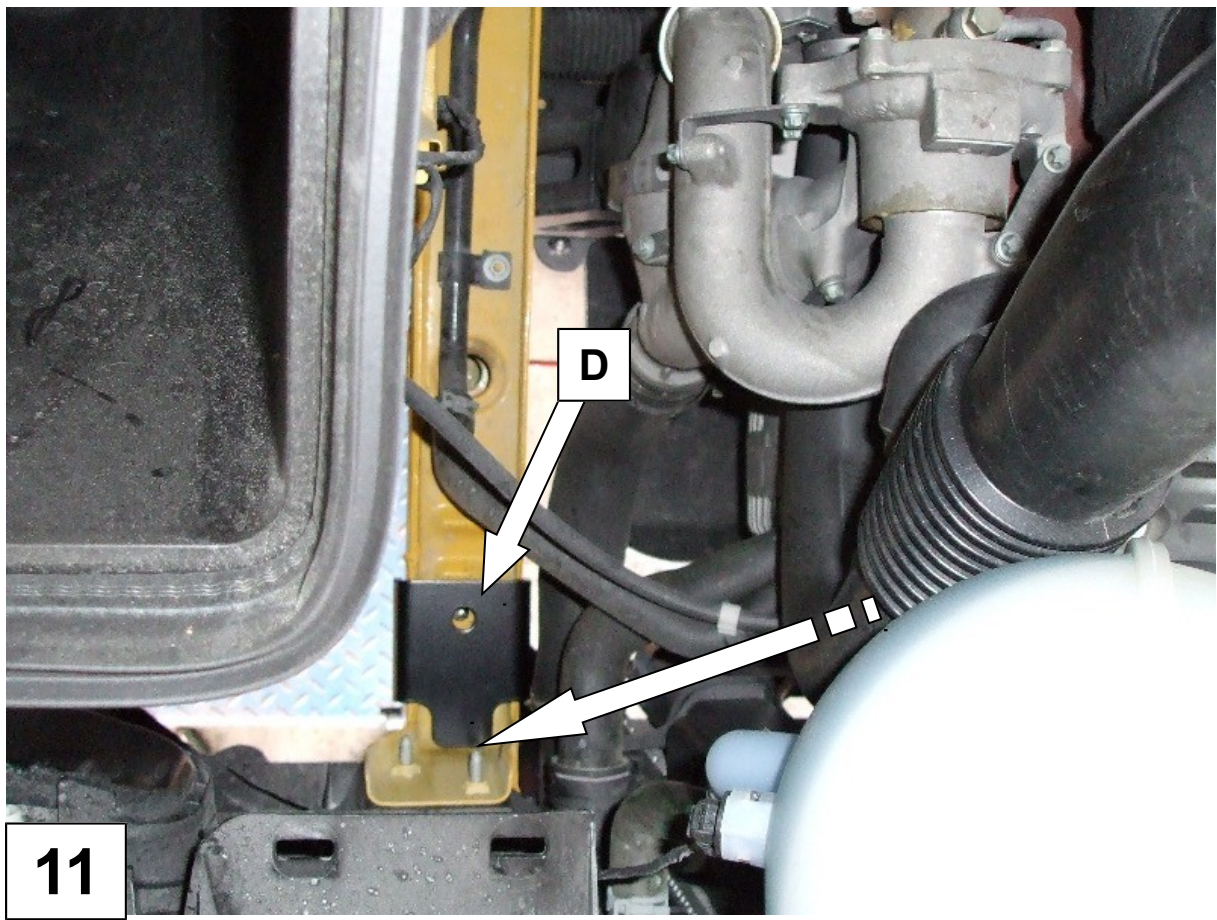

11

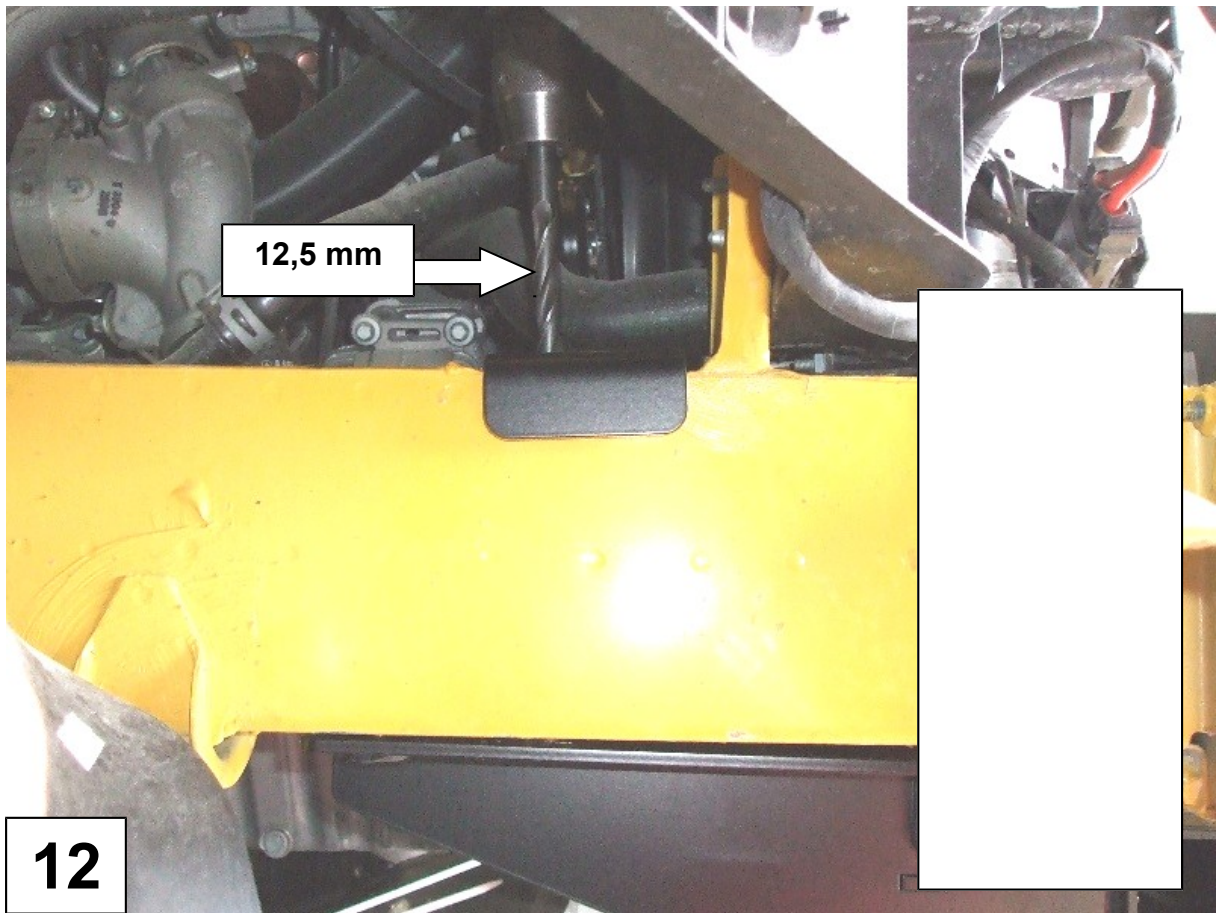

12

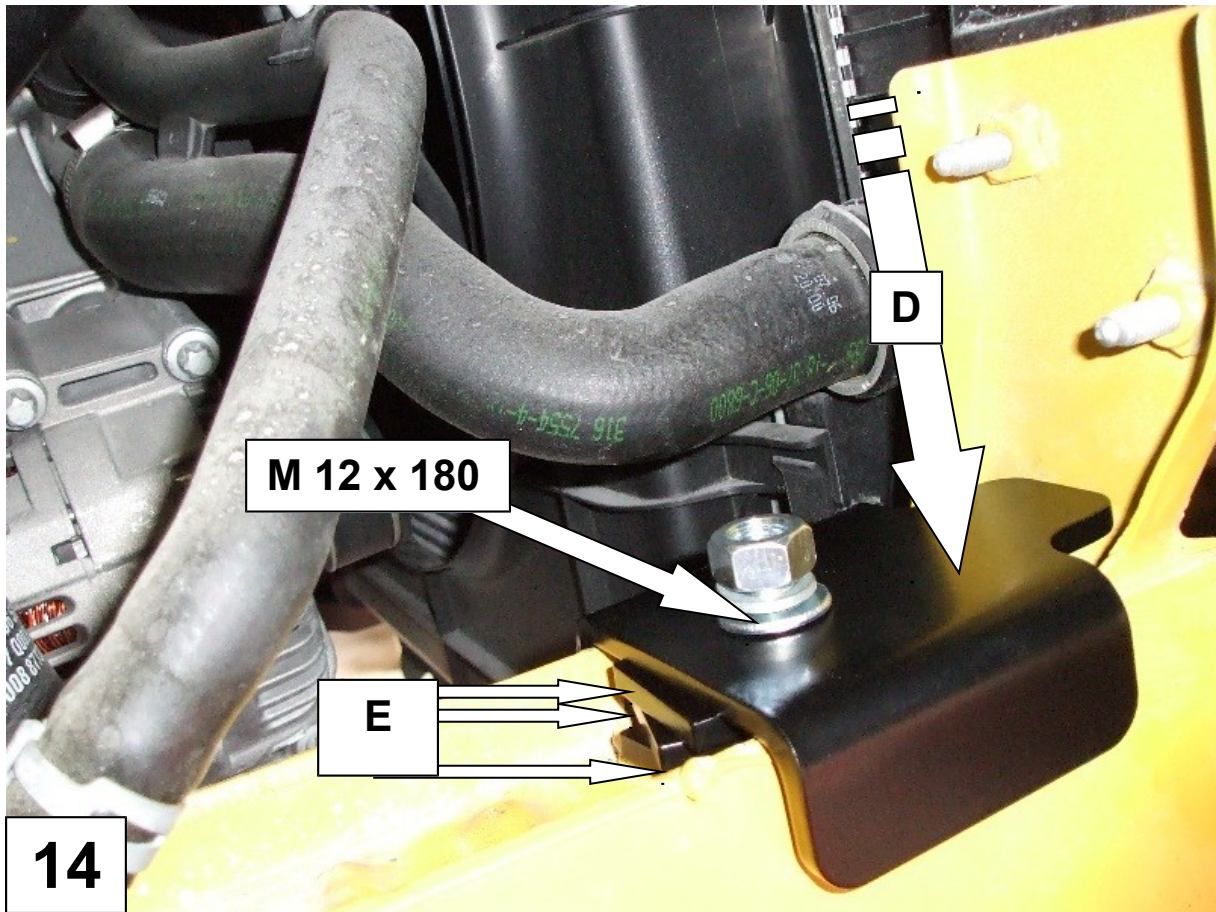
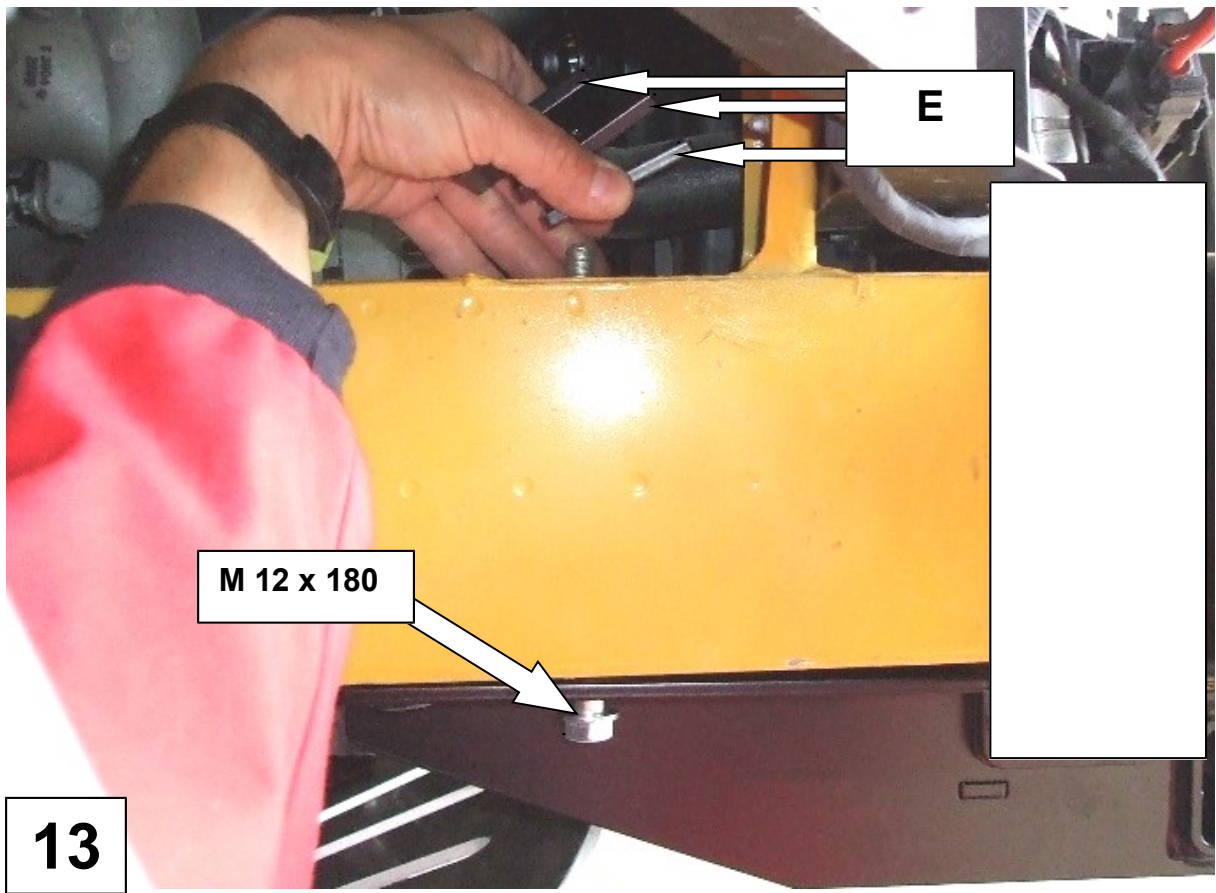

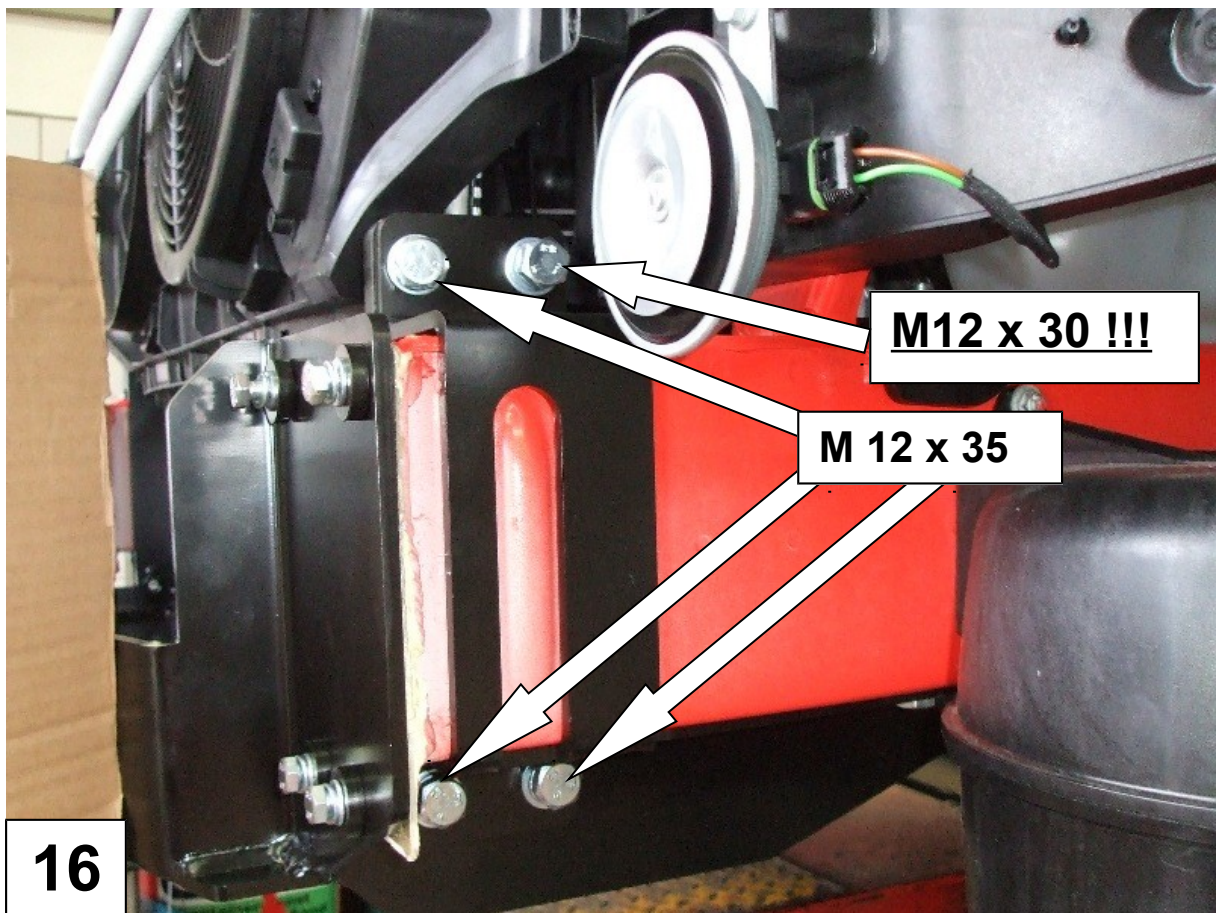
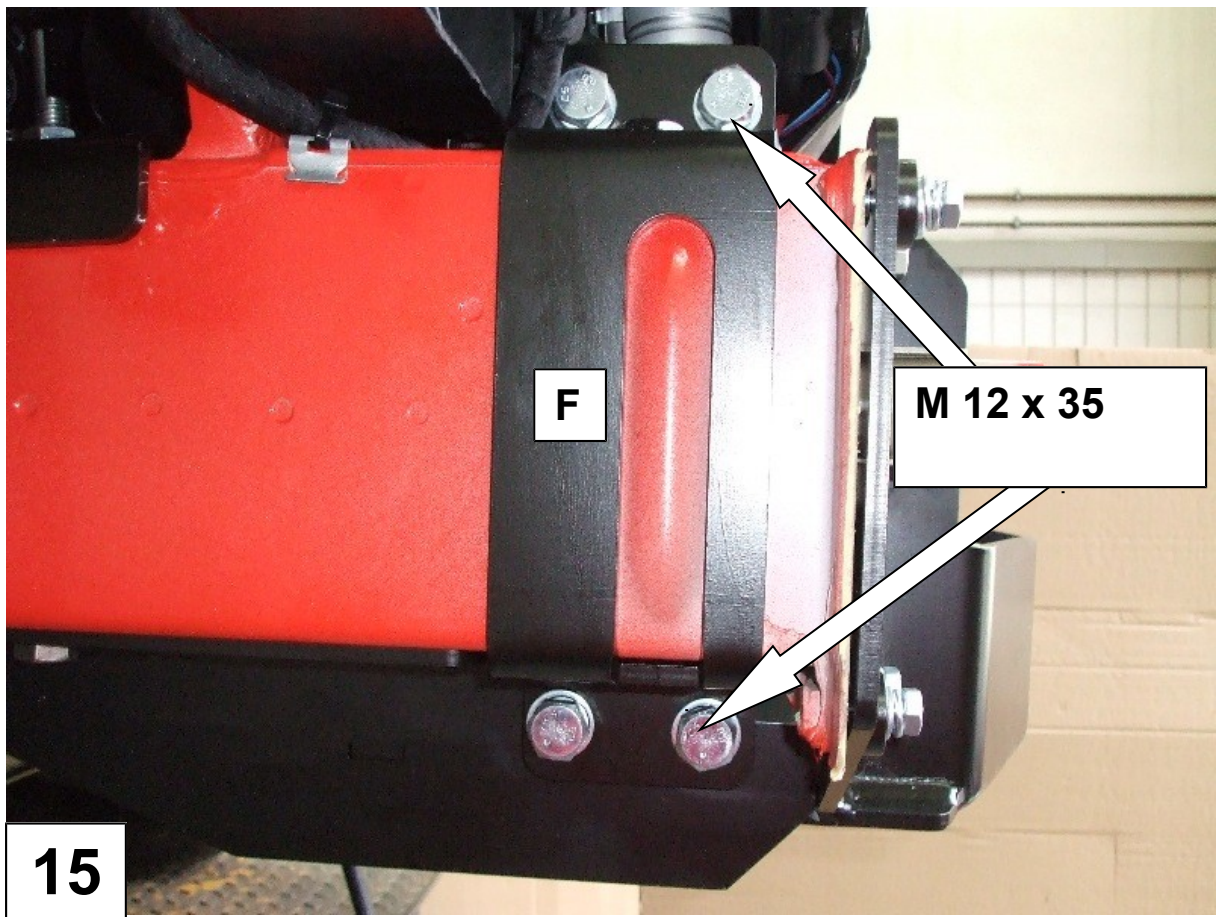

Ziehen sie die Schrauben in folgender Reihenfolge fest .

Tighten the screws in the following raw.

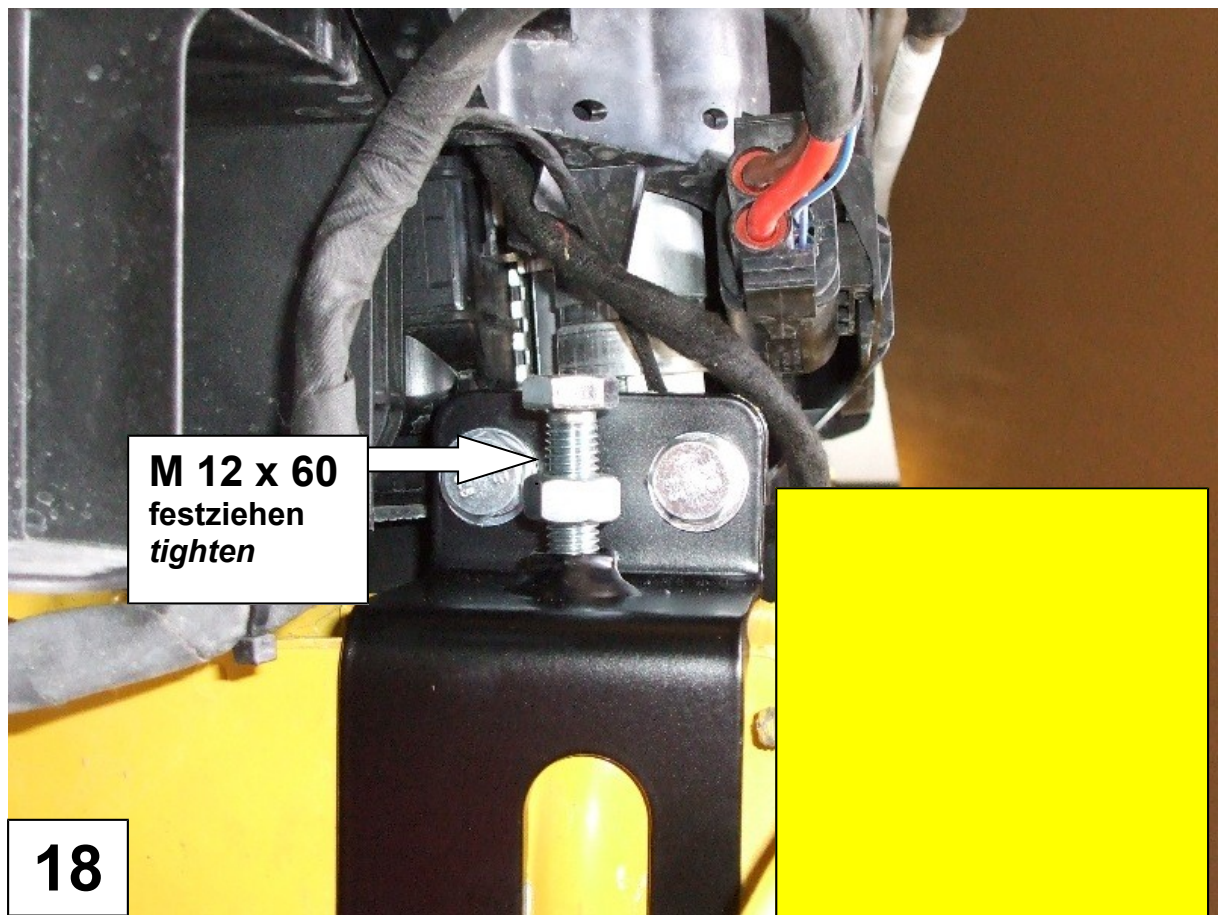
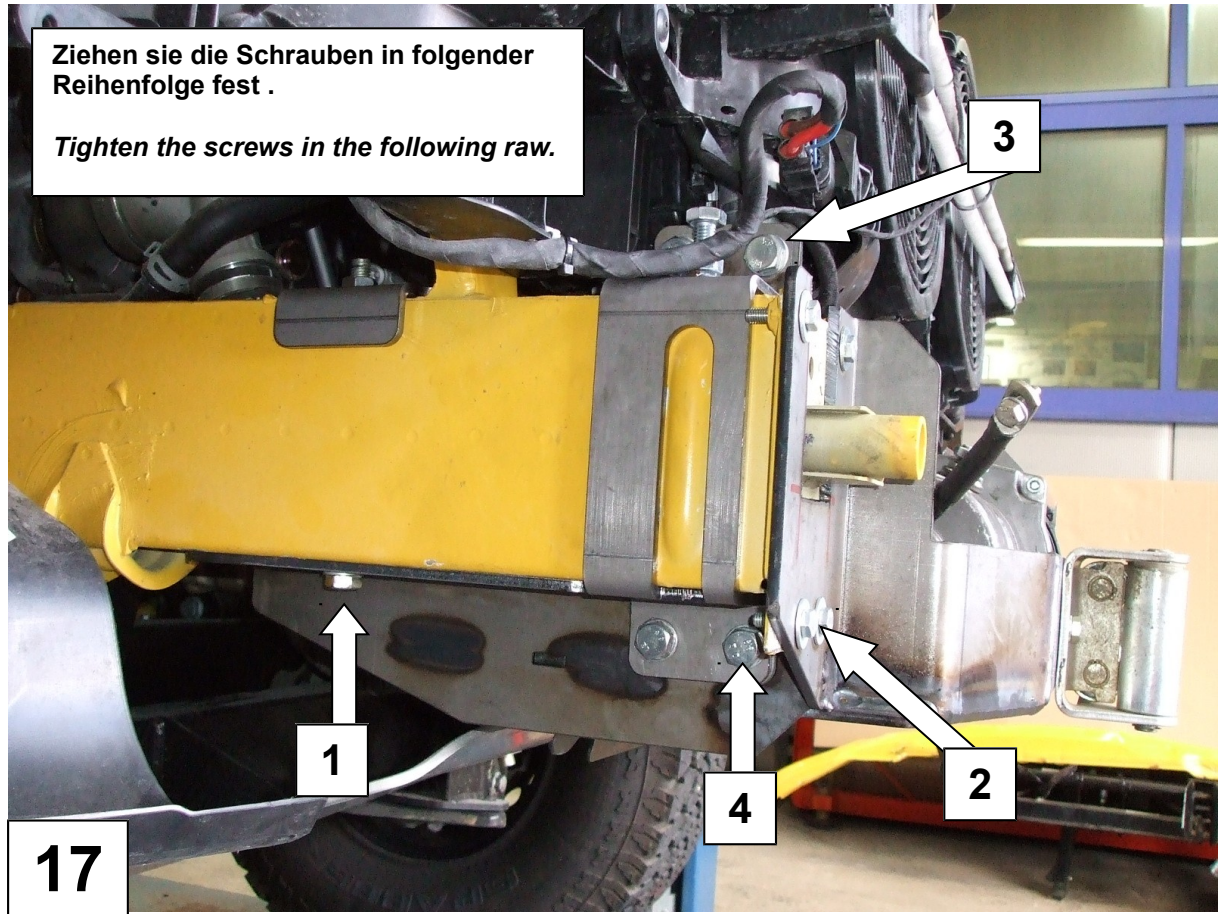

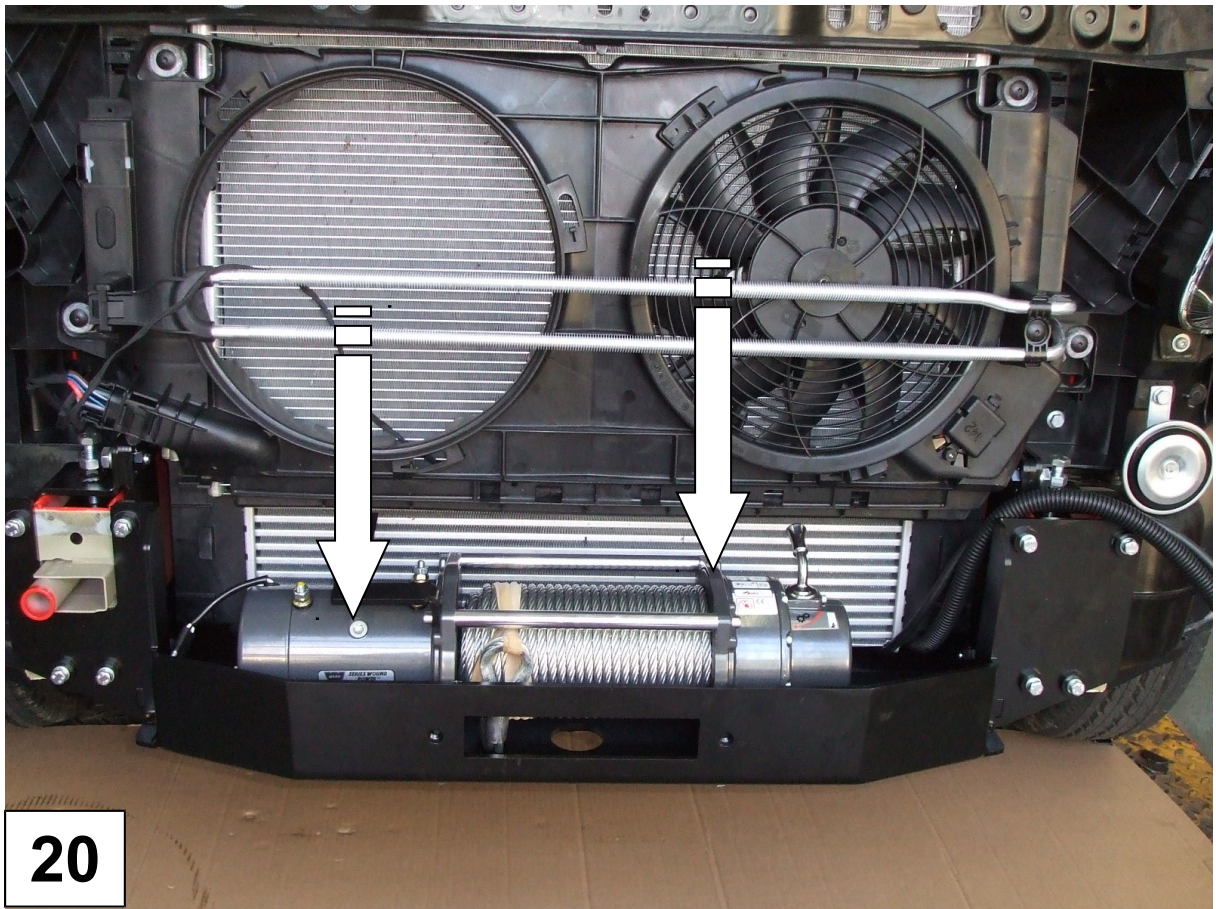
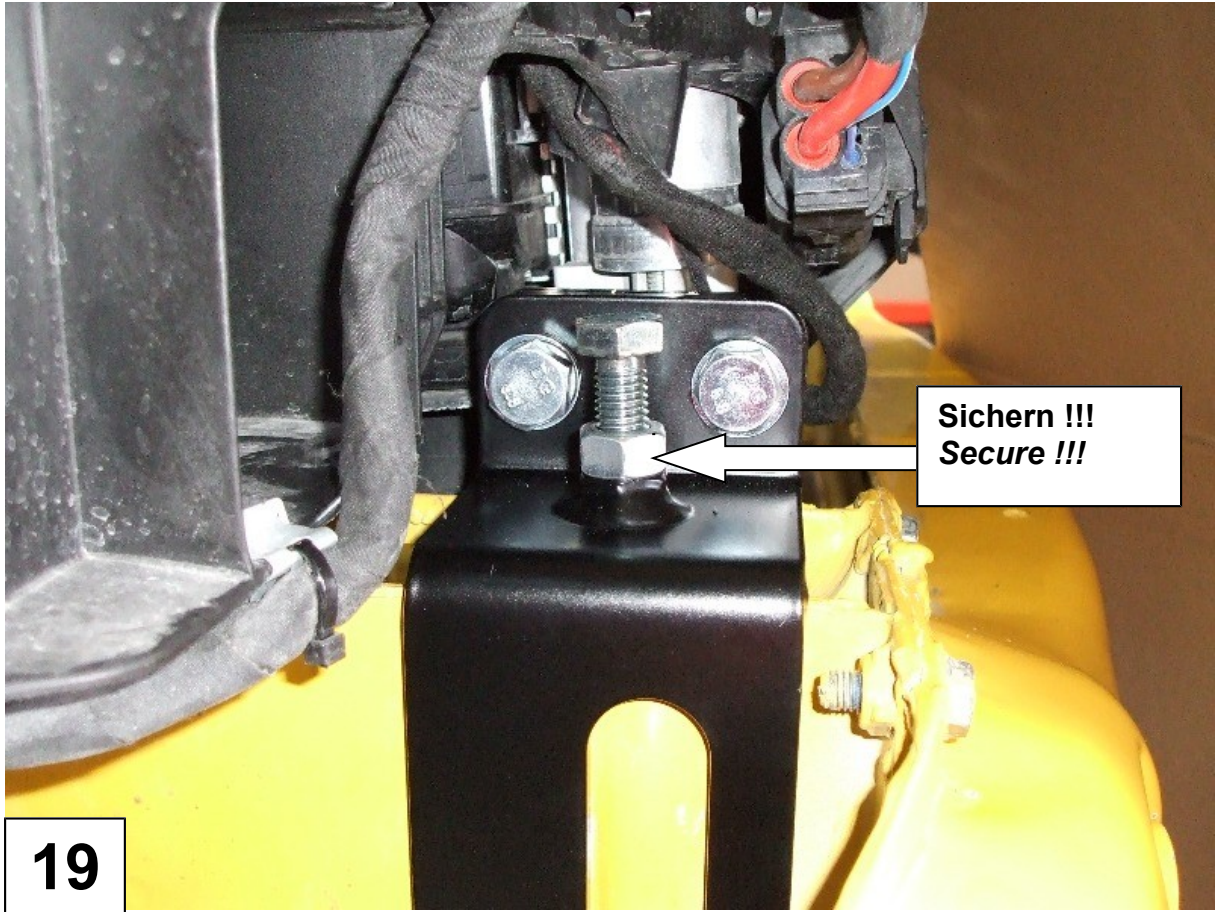

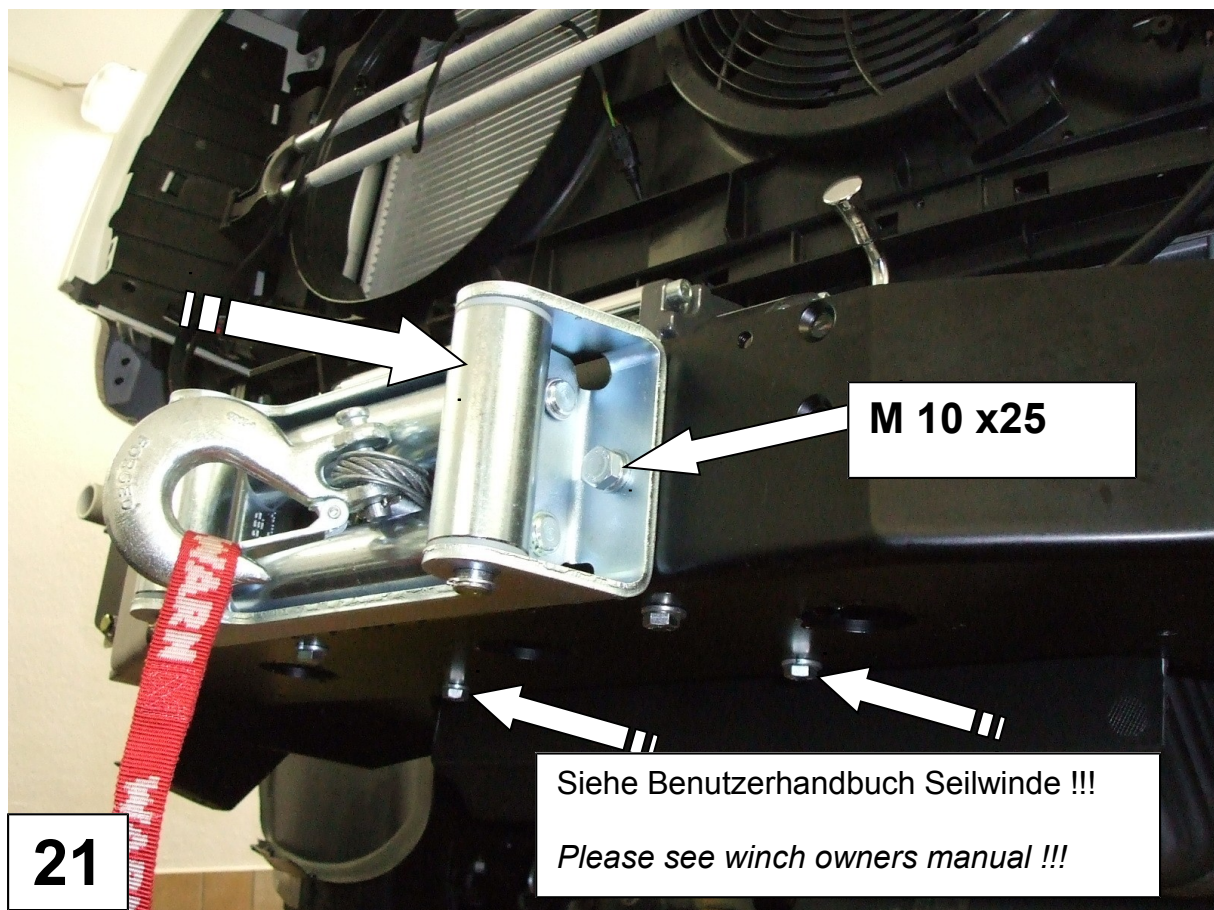

Achtung Schritte 22 bis 29 sind nur für VW Crafter!!
Attention Step 22 to 29 for VW Crafter only!!

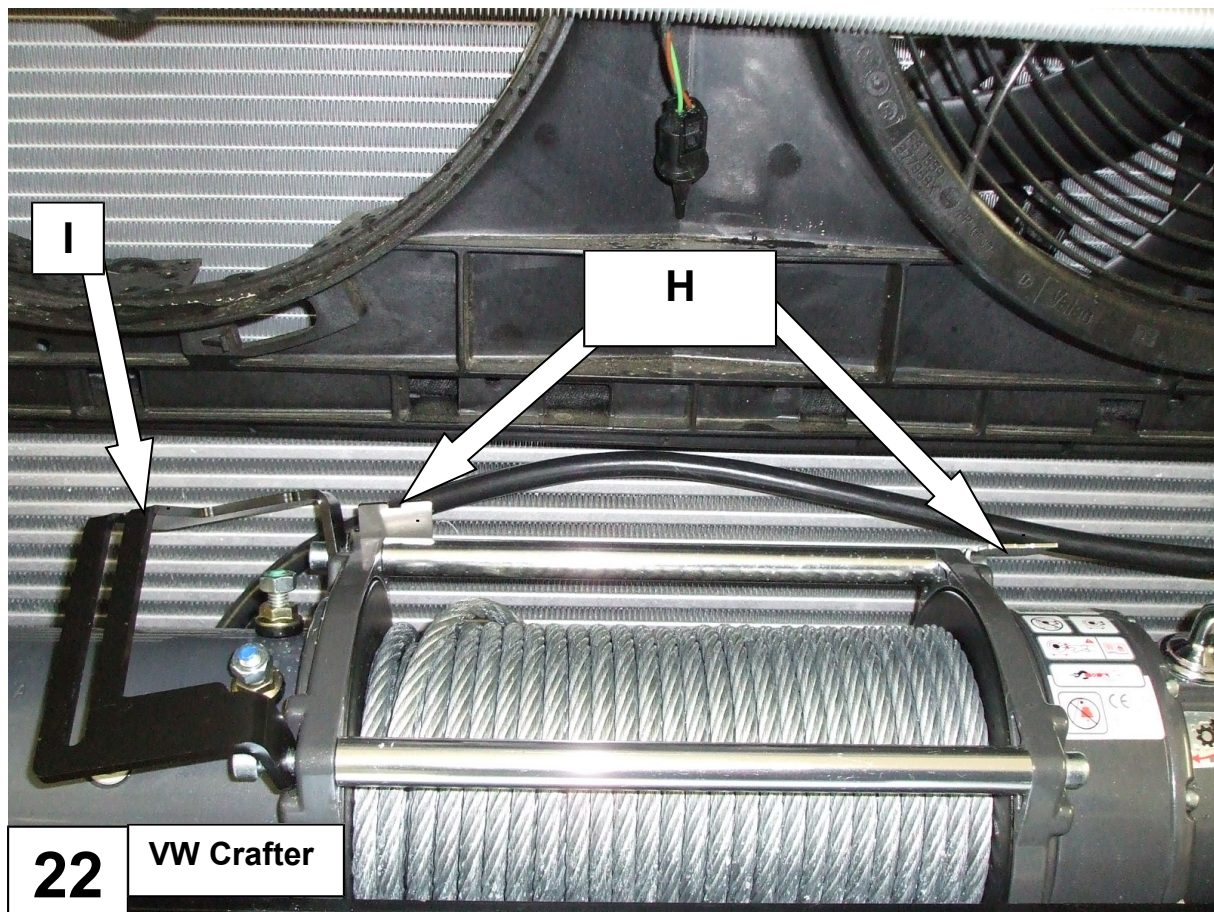

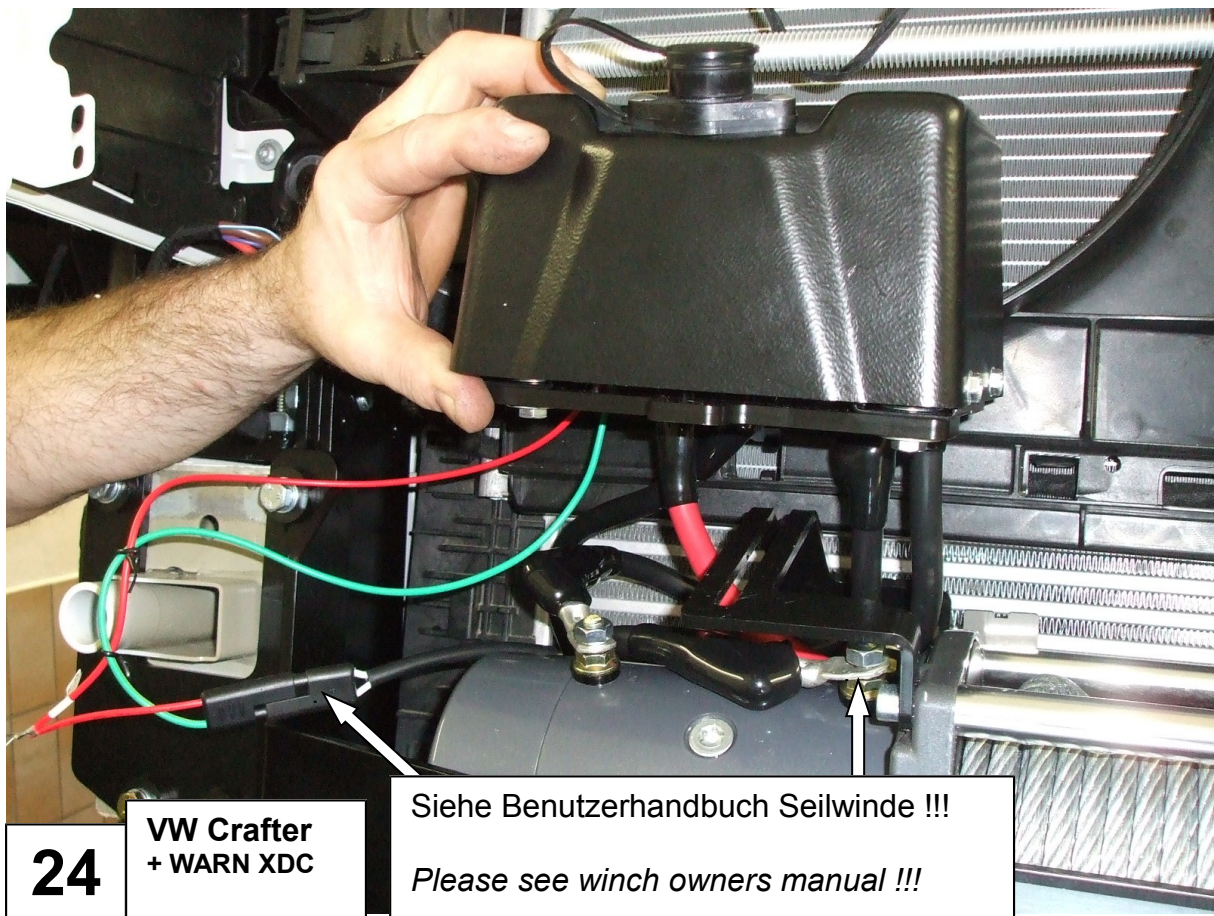
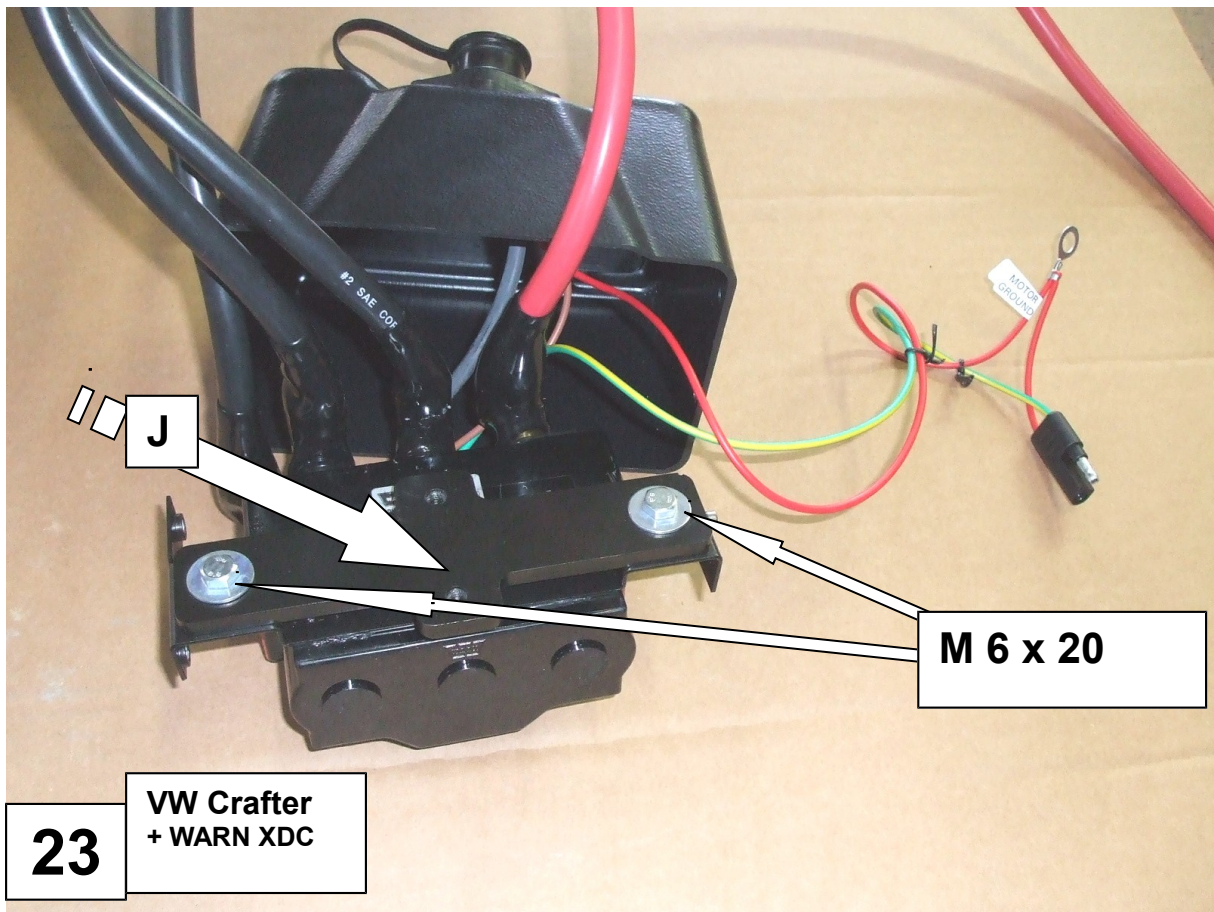

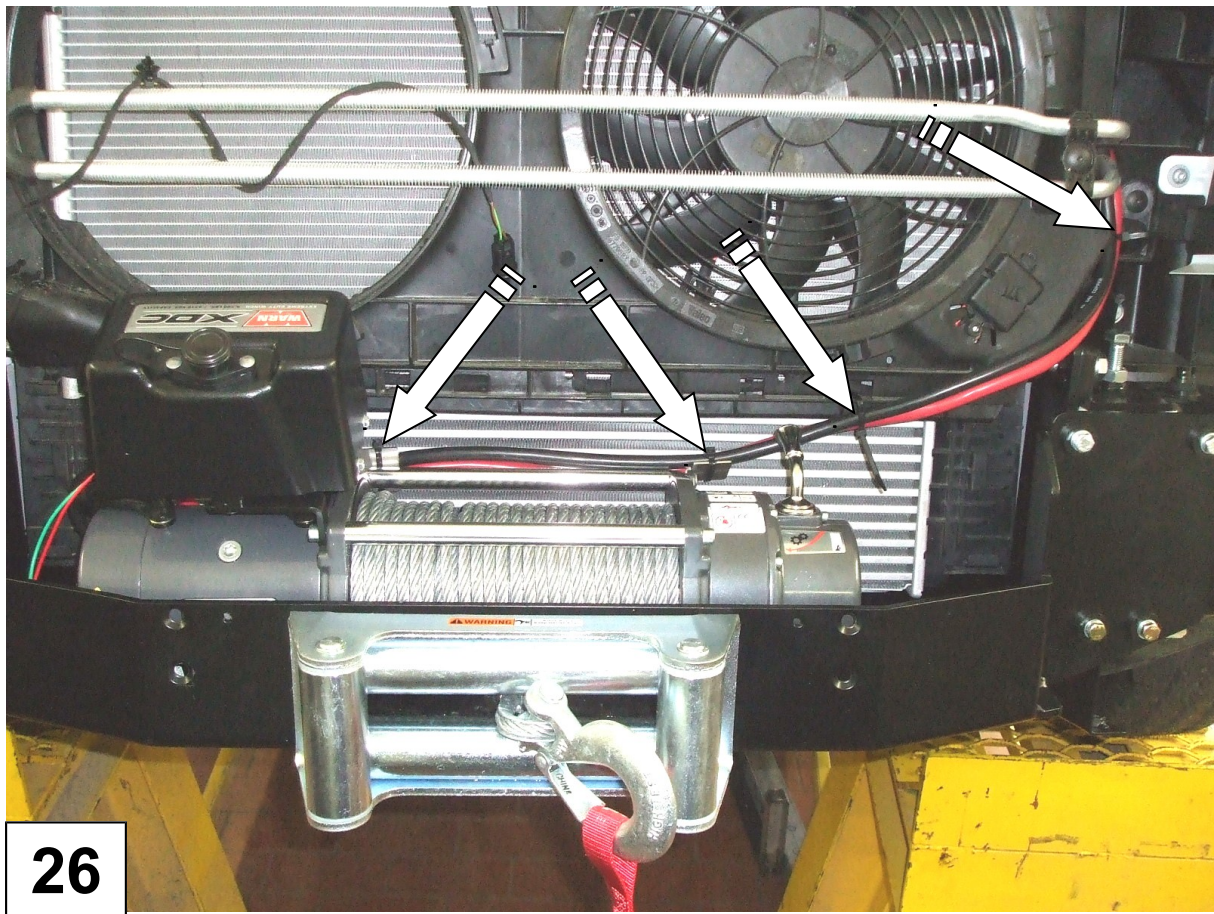
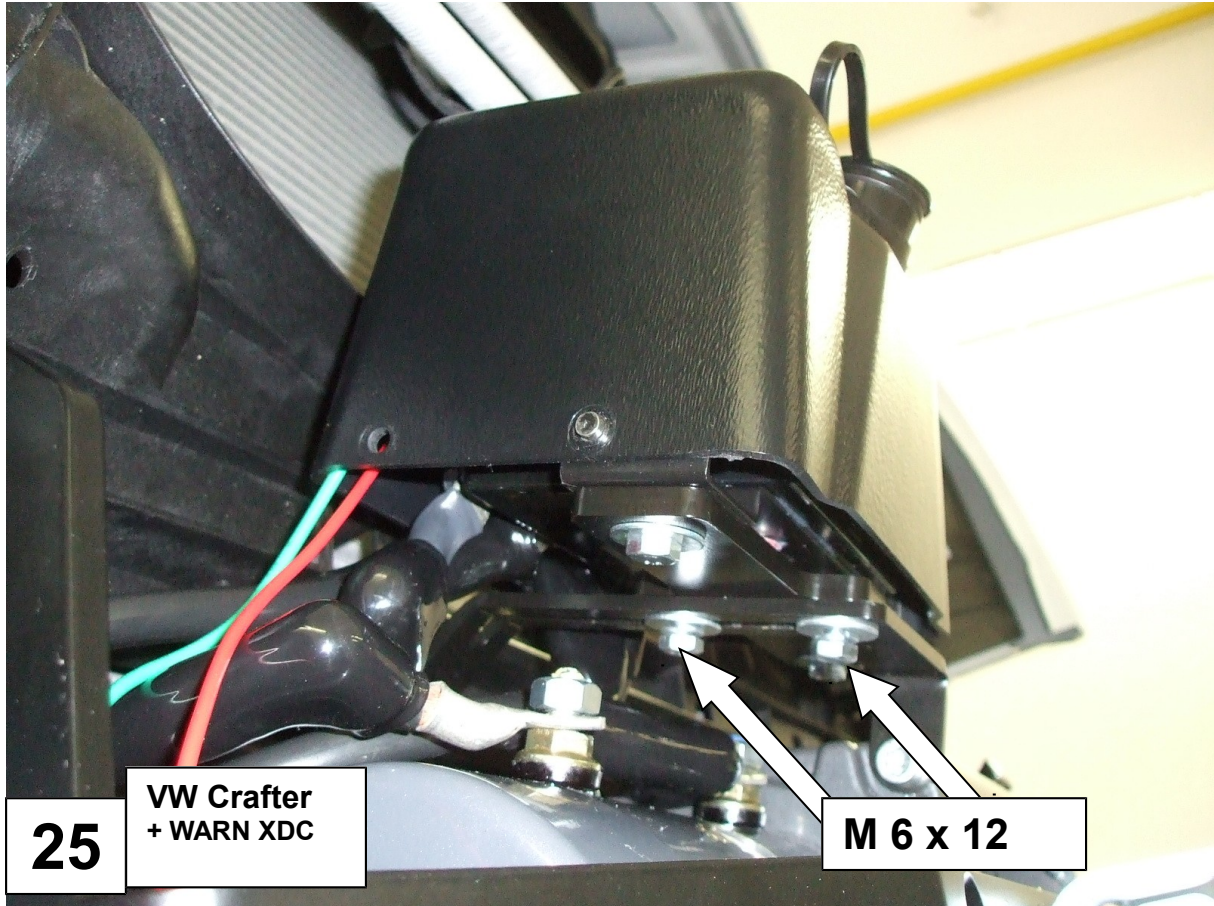

Ausschneiden !!!
Cut out !!!

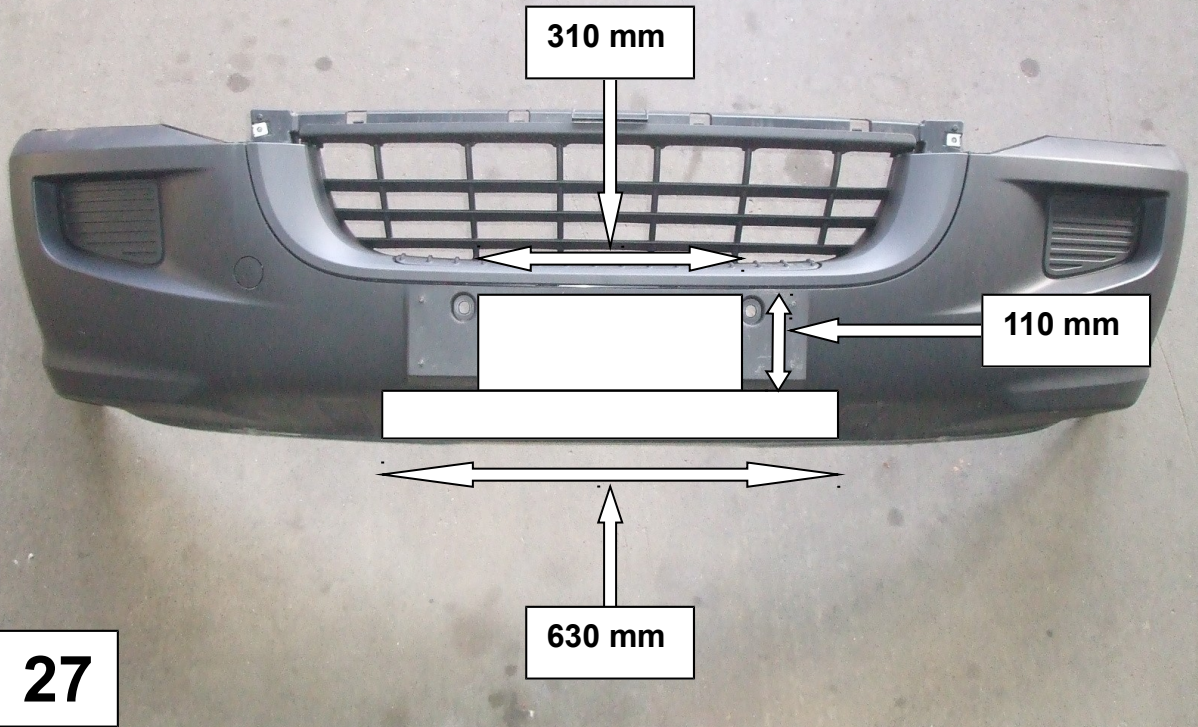

Ausschneiden !!!
Cut out !!!





**Achtung Schritte 30 bis 35 sind nur für Mercedes Sprinter!!
Attention step 30 to 35 for Mercedes Sprinter only !!!**

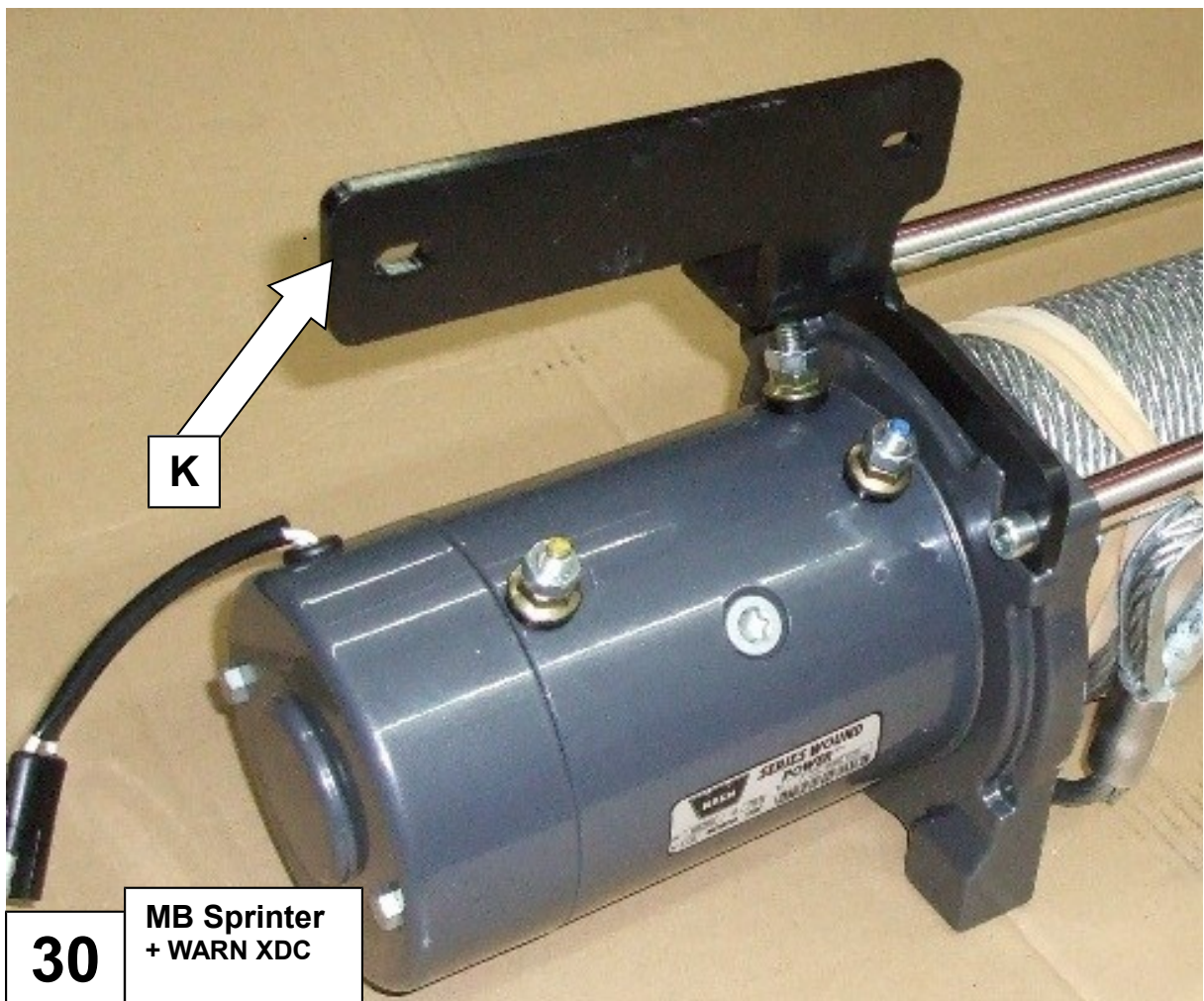

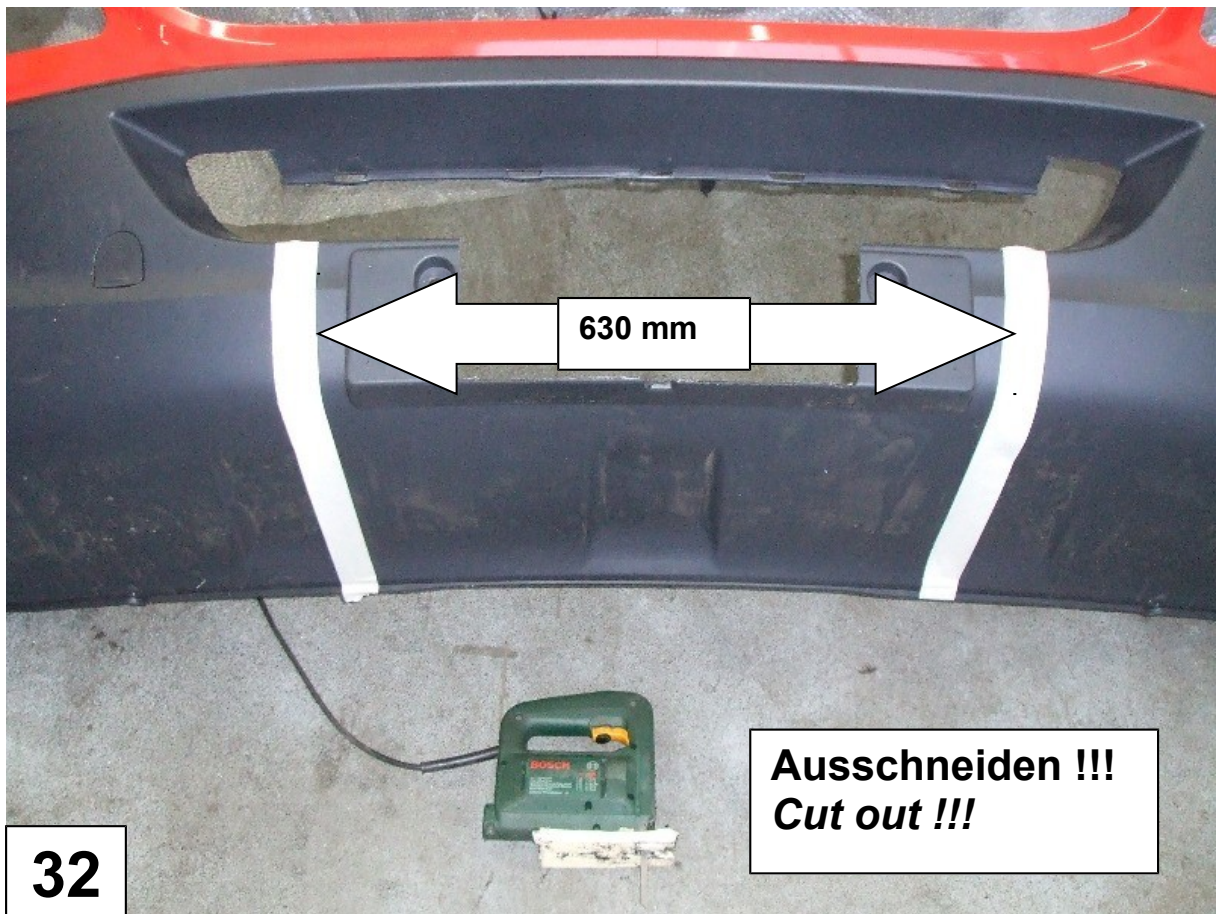
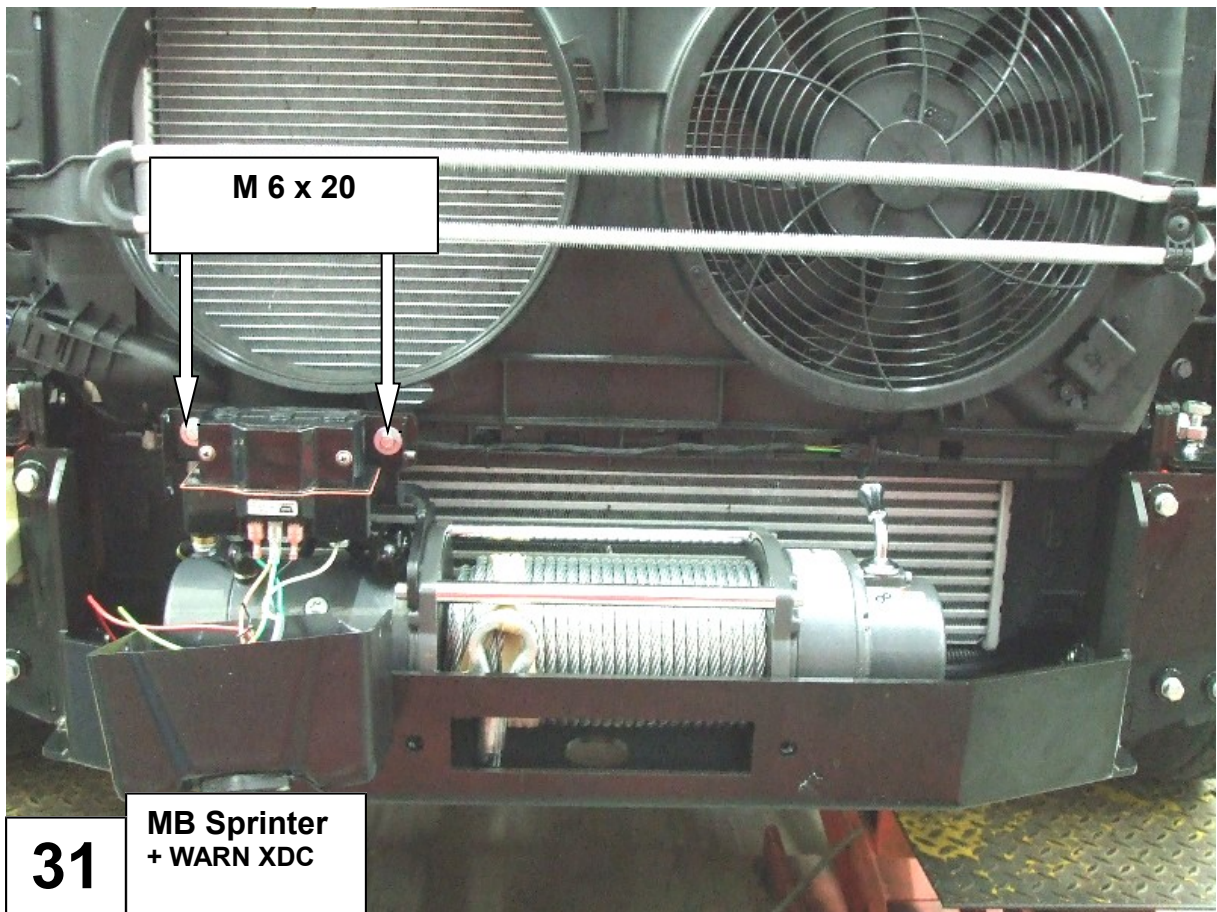





35