

# COLUMBUS SERIES INSTRUCTIONS





# WARNINGS

Avvertenze • Avertissement • Warnungen



MODELS Modèle Modèles Modelli	TENT WEIGHT Zeltgewicht Poids de la tente Peso della tenda	MAXIMUM OCCUPANTS WEIGHT Maximales Bewohnergewicht Poids Maximum des occupants Peso massimo degli occupanti	MEASURES WHEN CLOSE Abmessungen bei geschlossenem Zelt Dimensions (tente fermée) Misure chiuse	MEASURES WHEN OPEN Abmessungen bei offenem Zelt Dimensions (tente ouverte) Misure aperte	INTERNAL VOLUME* Innenvolumen Capacité interne de la tente Capacità interna
Columbus Small Columbus Medium Columbus Large	ca. 59 kg ca. 65 kg ca. 77 kg	ca. 180 kg ca. 230 kg ca. 280 kg	130x210x30 cm 145x210x30 cm 165x215x30 cm	130x110x150 cm 145x210x150 cm 165x210x150 cm	ca. 196 l ca. 220 l ca. 260 l
Columbus Variant Small Columbus Variant Medium Columbus Variant Large Columbus Variant Small X-Long Columbus Variant Medium X-Long Columbus Variant X-Large	ca. 59 kg ca. 65 kg ca. 77 kg ca. 64 kg ca. 71 kg ca. 99 kg	ca. 180 kg ca. 230 kg ca. 280 kg ca. 180 kg ca. 230 kg ca. 280 kg	130x210x30 cm 145x210x30 cm 165x215x30 cm 130x230x30 cm 145x230x30 cm 180x230x30 cm	130x110x150 cm 145x210x150 cm 165x210x150 cm 130x110x150 cm 145x210x150 cm 180x230x150 cm	ca. 196 l ca. 220 l ca. 260 l ca. 210 l ca. 235 l ca. 300 l
Columbus Carbon Fiber Small Columbus Carbon Fiber Medium	ca. 49 kg ca. 55 kg	ca. 180 kg ca. 230 kg	130x210x30 cm 145x210x30 cm	130x110x150 cm 145x210x150 cm	ca. 196 l ca. 220 l

The GRP (fiberglass) outer shells are all handmade and finished, therefore some variations may appear in the finished weights (Manufacturers tolerance rate is within 10%).

Da die Herstellung der Glasfaserschalen manuell erfolgt, können unterschiedliche Zeltgewichte auftreten.

(Da es sich bei Dachzelten um handwerklich gefertigte Produkte handelt, sind Abweichungen bei Gewichten und Abmessungen im Rahmen üblicher Toleranz (10% möglich).

La production des coques en fibre résine est réalisée à la main, raison pour laquelle il est possible de noter des différences de poids au niveau de la tente (la marge de tolérance de fabrication est de l'ordre de 10%).

La produzione dei gusci in vetroresina è realizzata manualmente, di conseguenza è possibile riscontrare delle variazioni del peso della tenda (la tolleranza nell'ambito della costruzione di fabbrica è del 10%).

(\* Approximate value indicating the volumetric capacity of the upper shell of the tent, when the tent is closed

Ungefähres Volumen des Stauraums in der oberen Zeltschale, bei geschlossenem Zustand.

Valeur approximative indiquant la capacité volumétrique de la coque supérieure lorsque la tente est fermée

Valore approssimativo che indica, a tenda chiusa, la capacità volumetrica del guscio superiore.

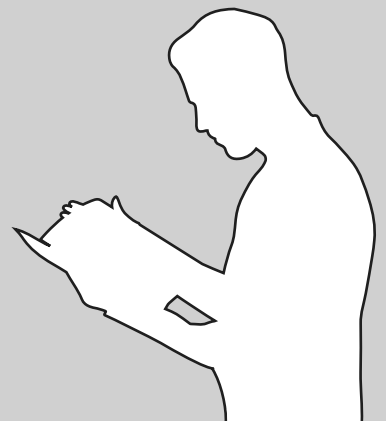
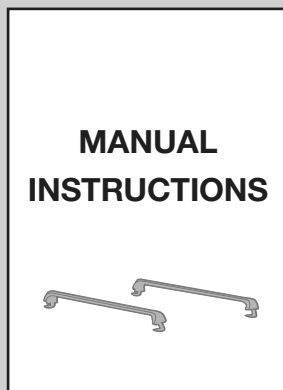
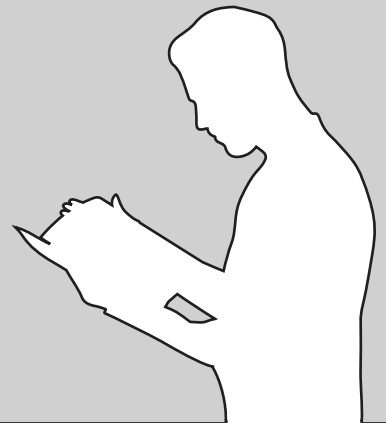
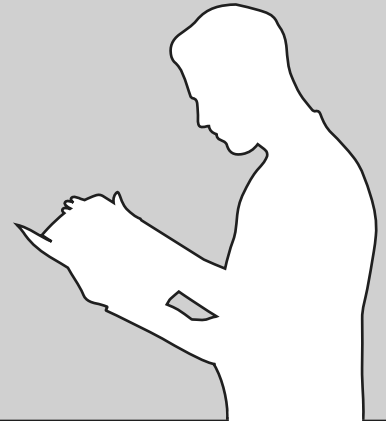
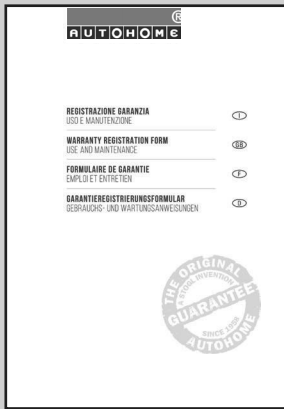
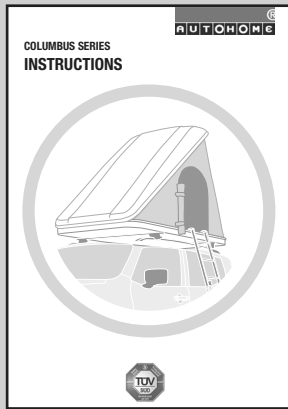

**Kg P1**



**Kg P2**



**(P1 + P2) ≤ Kg P<sub>MAX</sub>**



**Kg P<sub>MAX</sub>**

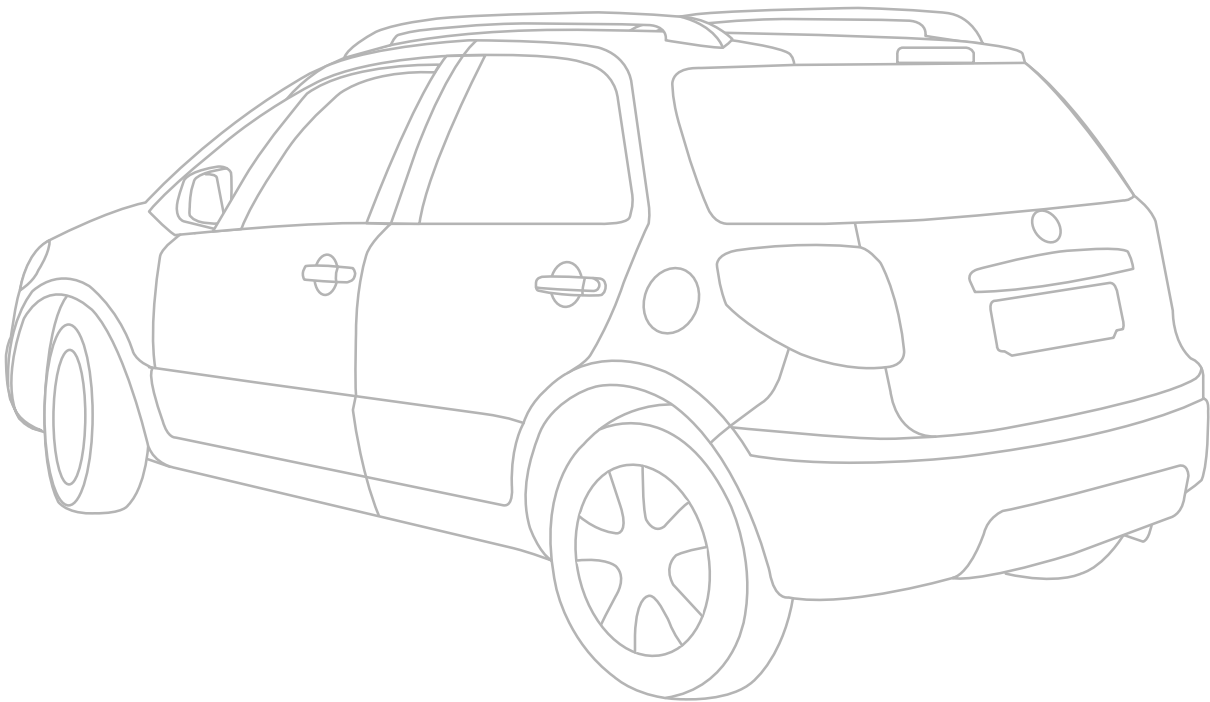
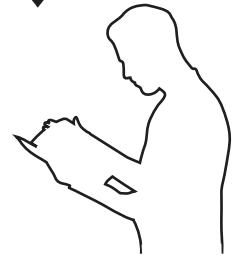

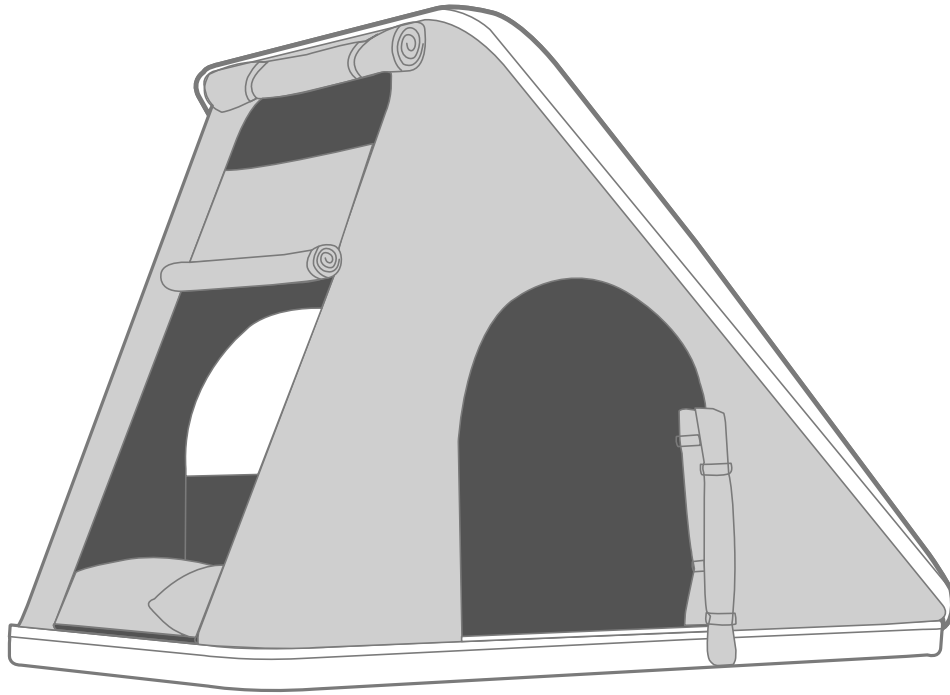

**UP**

**UNDER**

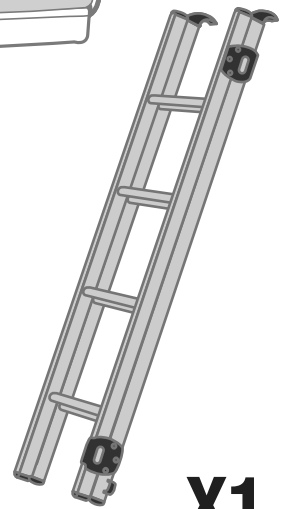
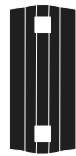
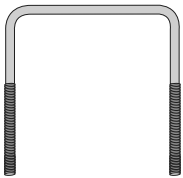

**X4**

**X4**

**X4**

**X8**

**X1**

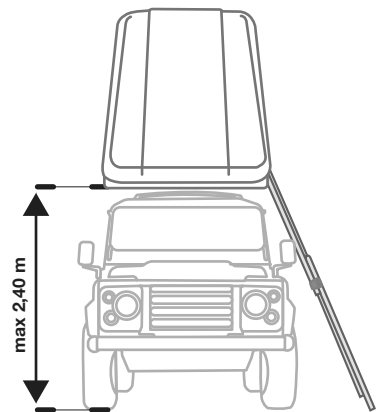
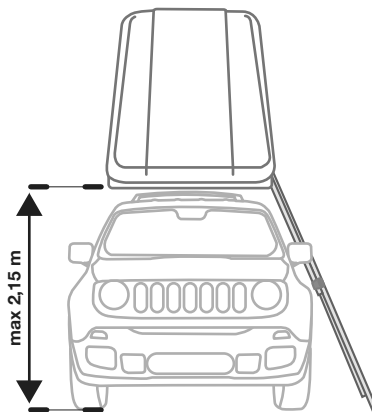
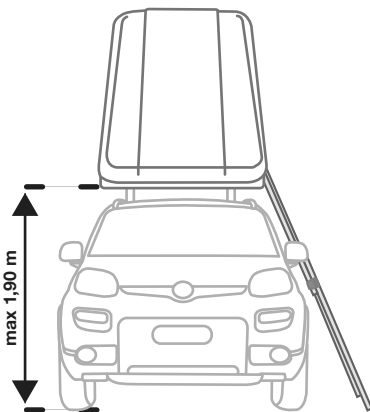

Ladder	H closed	H opened	Width	Thickness
STANDARD	120 cm	200 cm	34 cm	8 cm
4X4	130 cm	222 cm	34 cm	8 cm
EXTRA LONG	147 cm	247 cm	34 cm	8 cm

# POSITIONING

Posizionamento • Placement • Platzierung

1

## Minimum length

Lunghezza minima • Longueur minimale • Mindestlänge

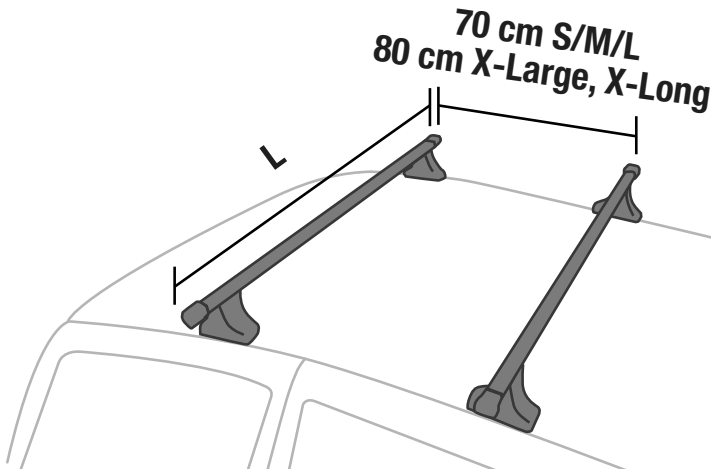

## ROOF TENT

L

Columbus **Small**

120 cm

Columbus **Medium**

140 cm

Columbus **Large**

160 cm

Columbus **X-Large**

180 cm

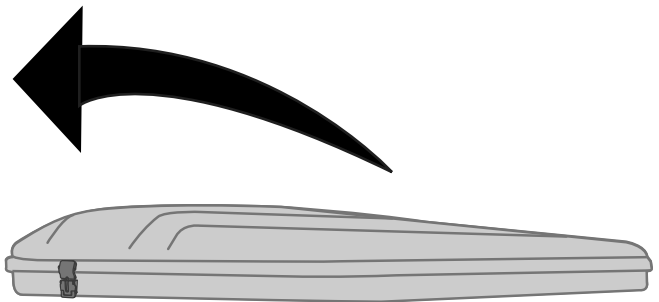
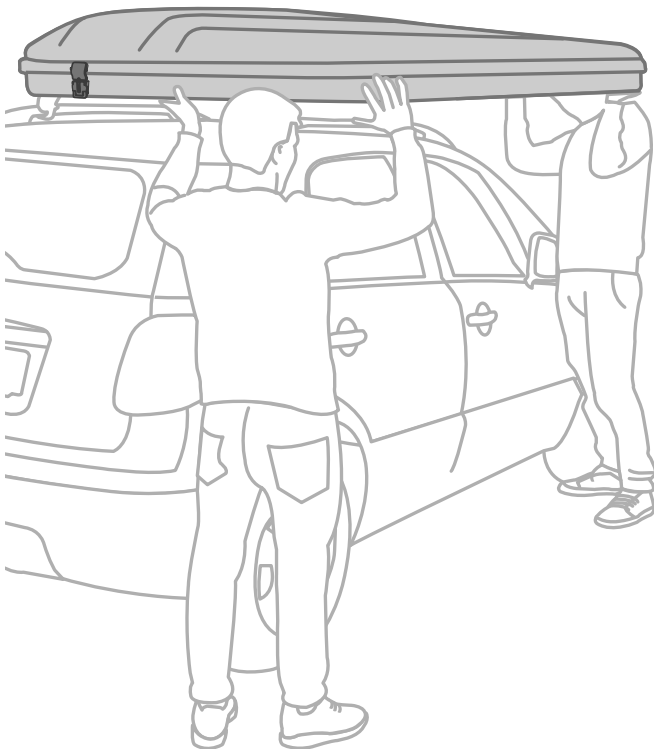

2

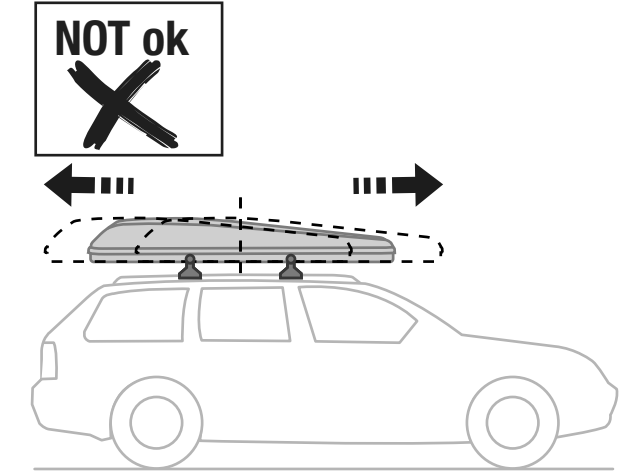
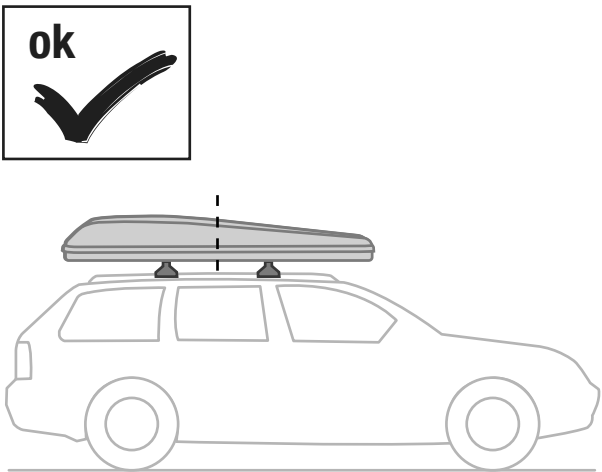
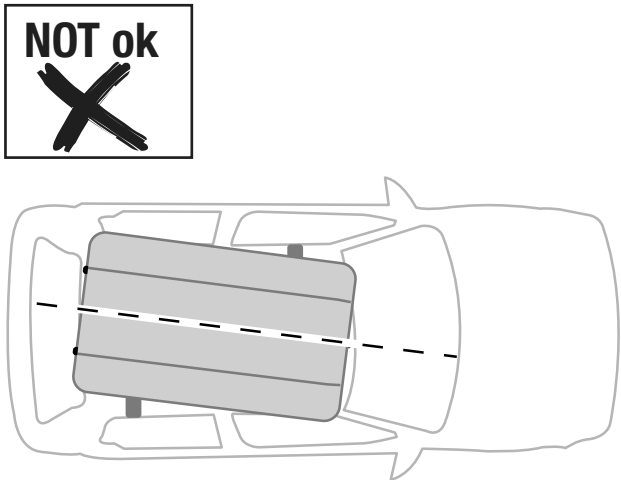
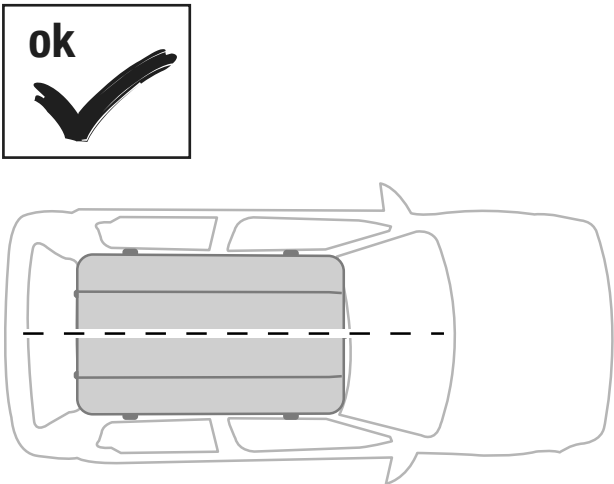
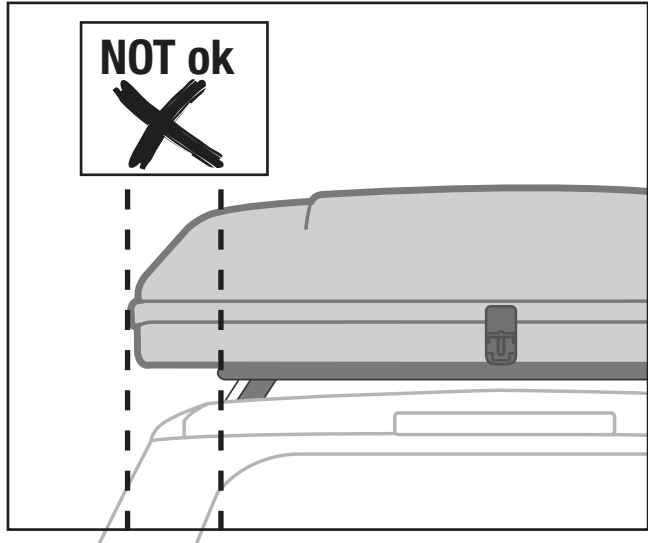
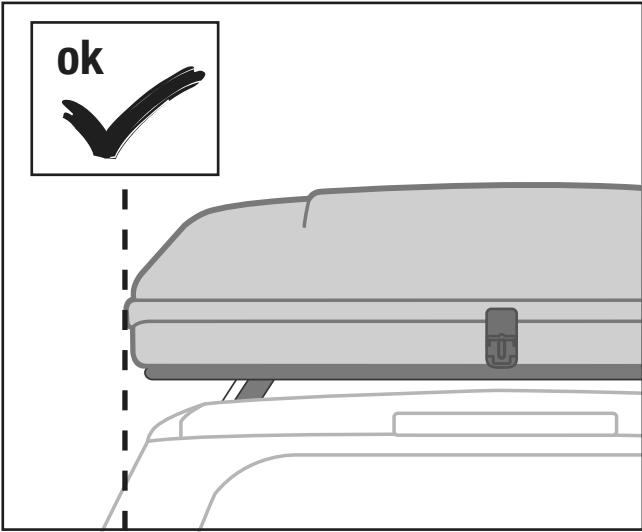



# FIXING

Fissaggio • Fixation • Befestigung

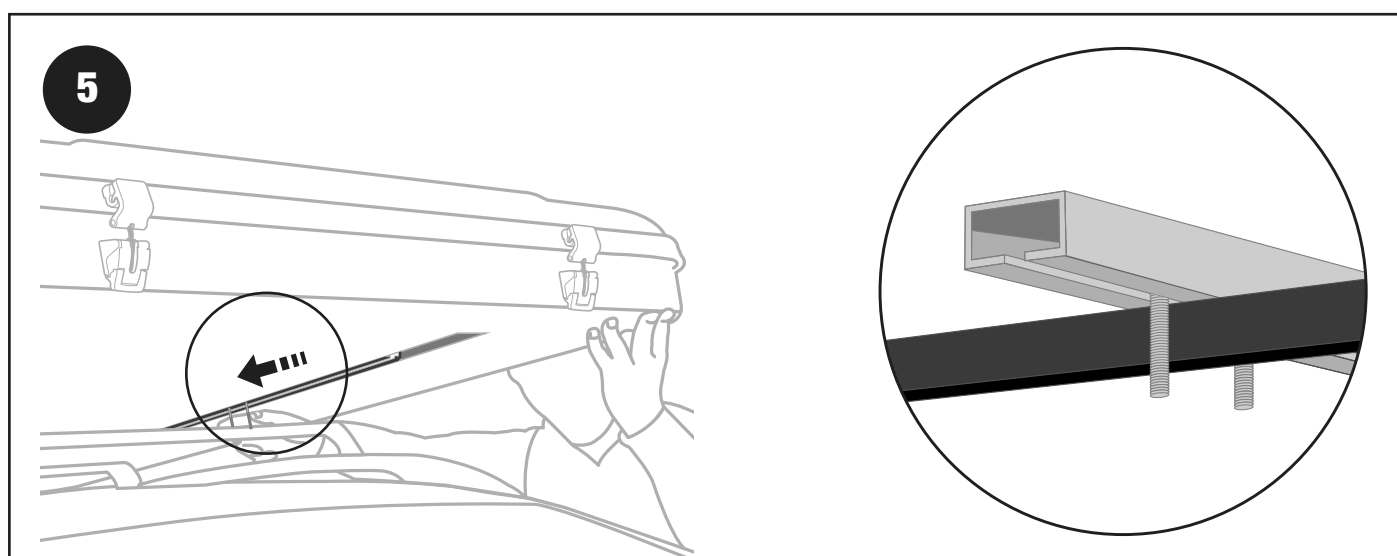
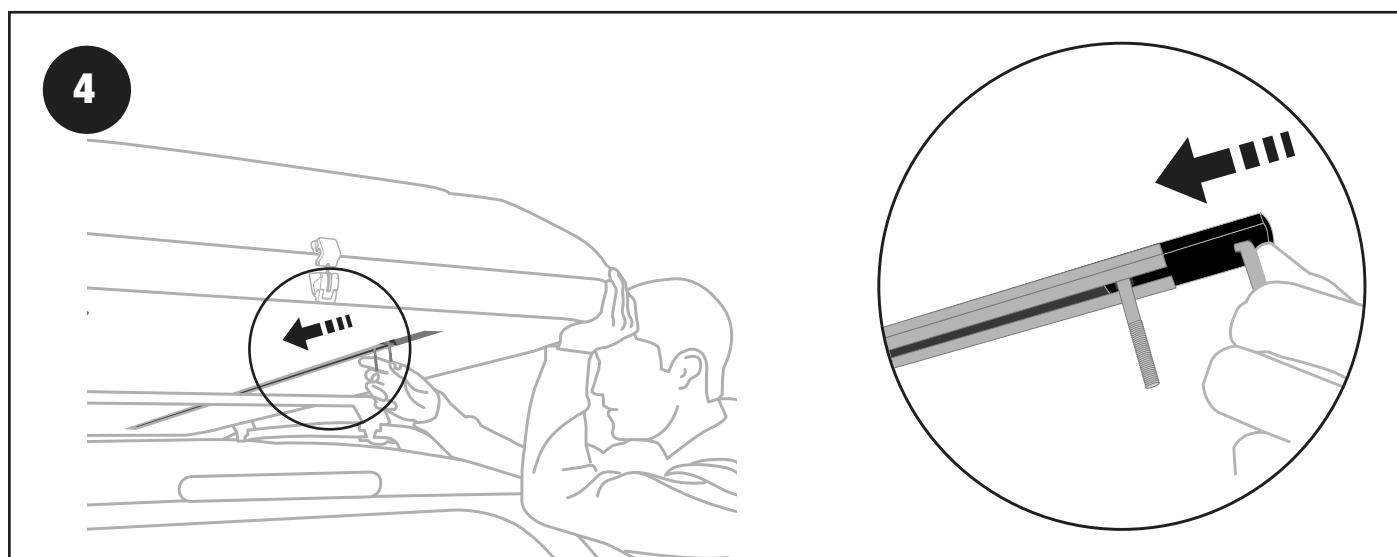
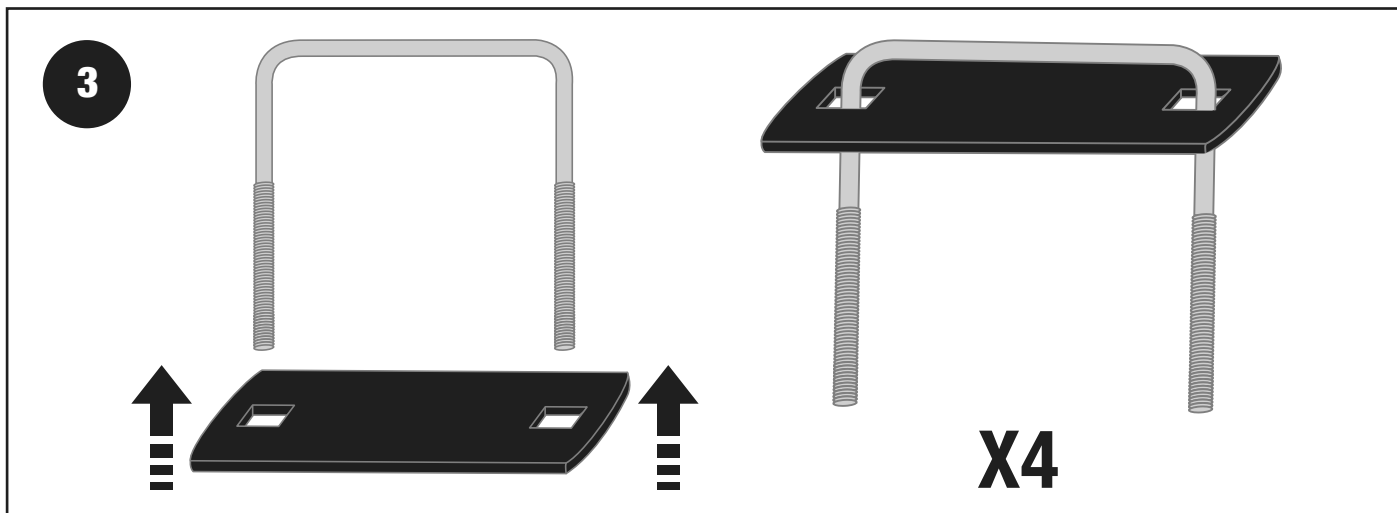

**6**

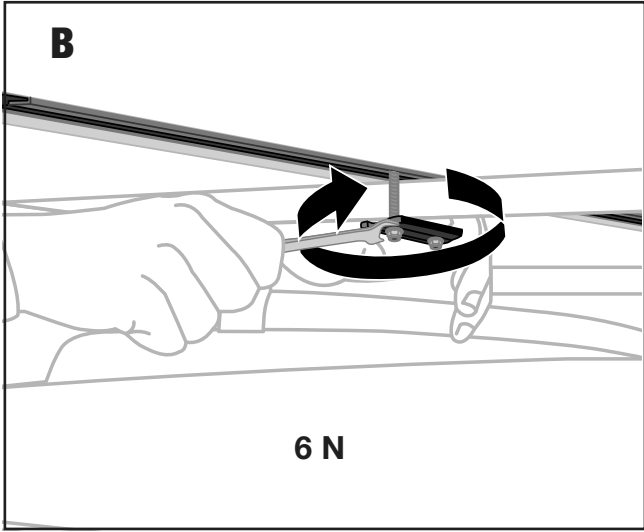
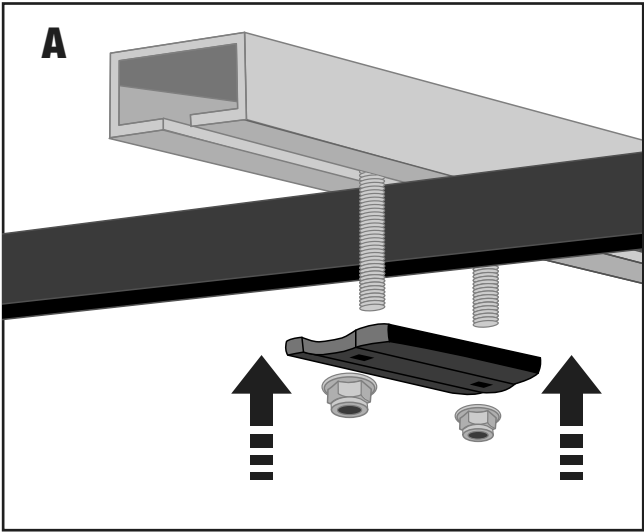

**7**

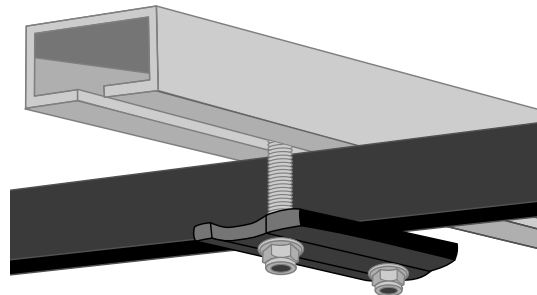
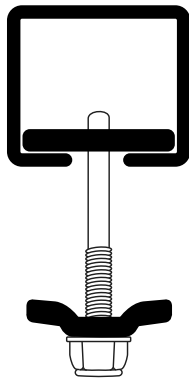
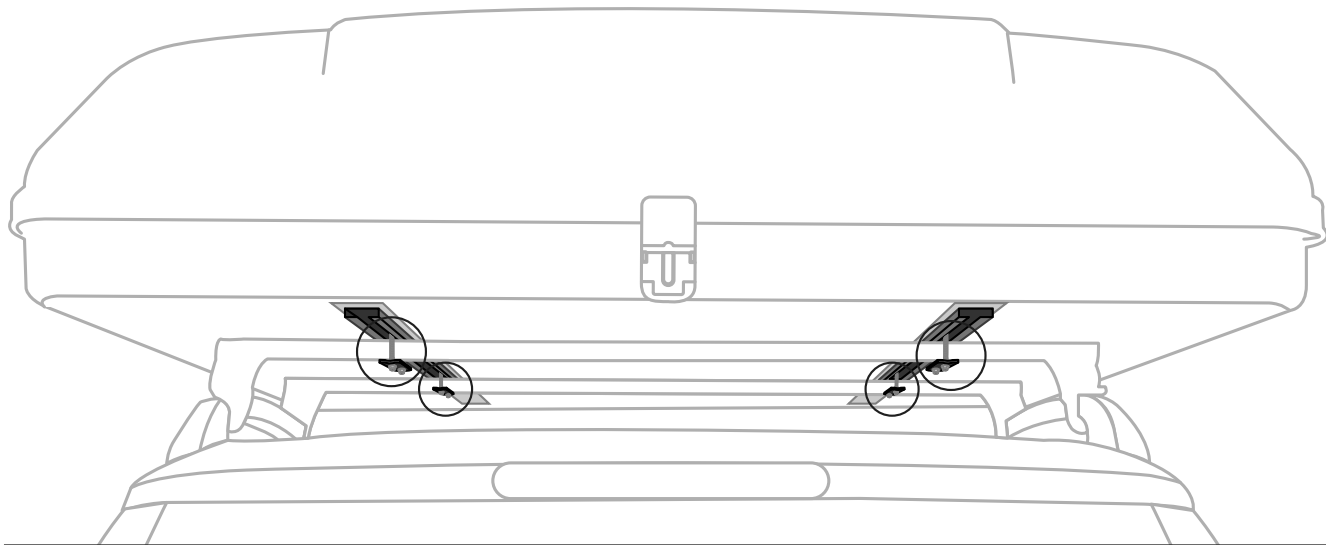

# OPENING

Apertura • Overture • Öffnung

8

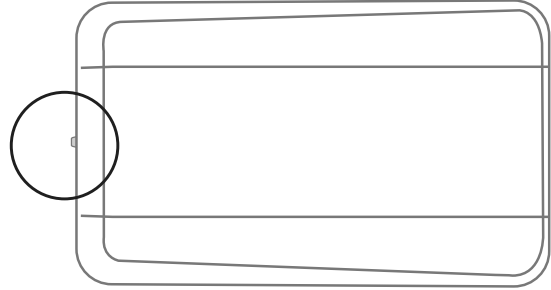
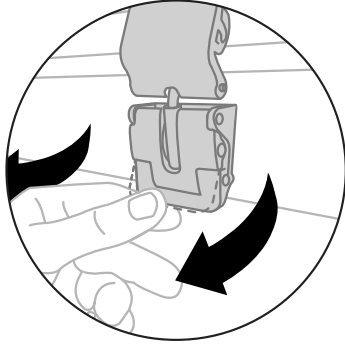

A

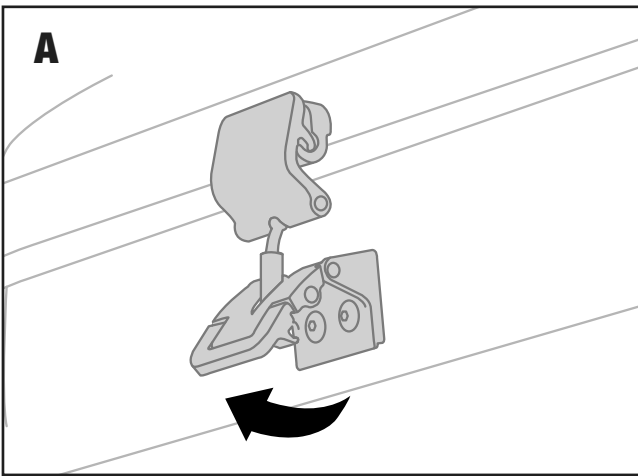

B

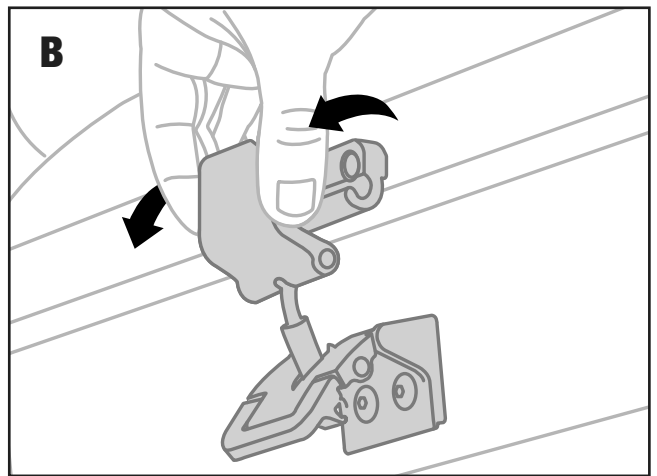

9

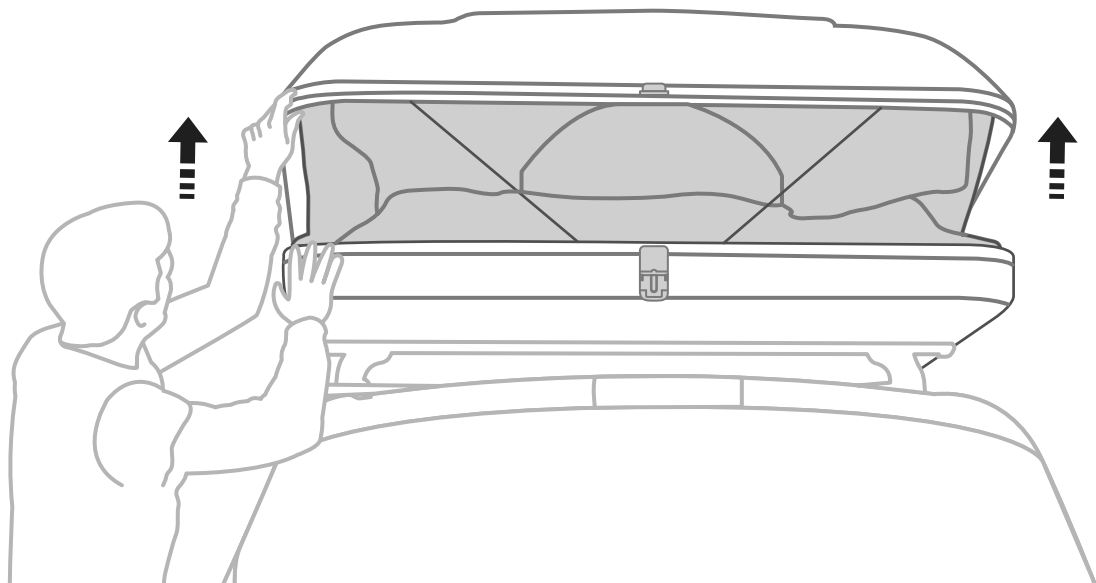

# WARNINGS

Avvertenze • Avertissement • Warnungen



10

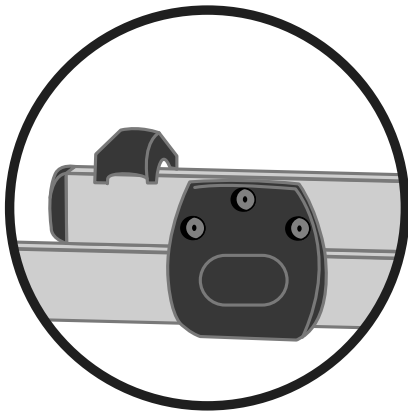
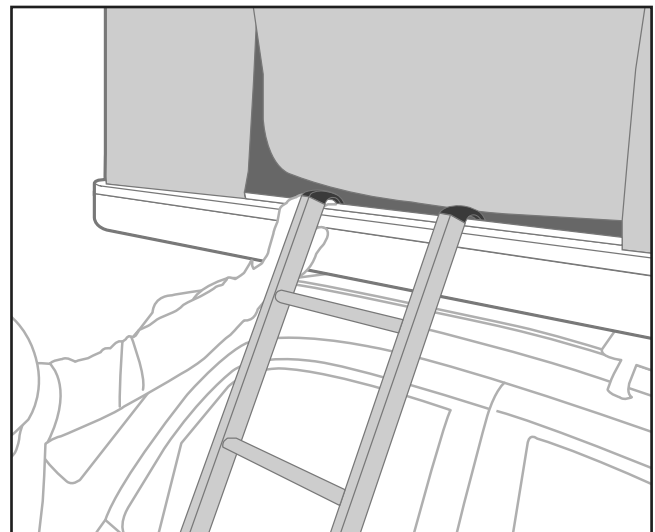
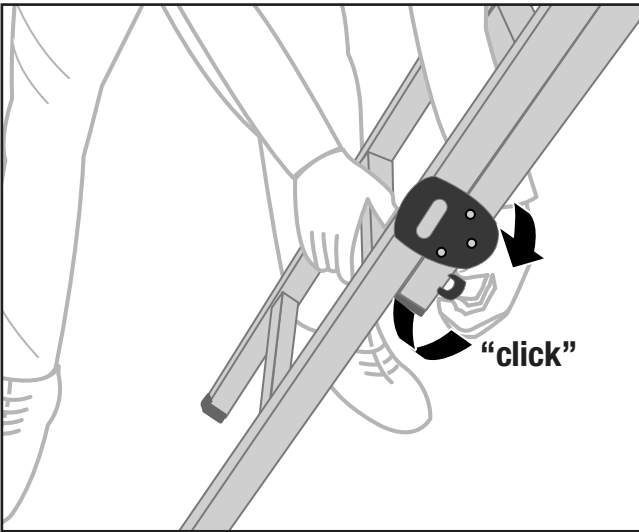
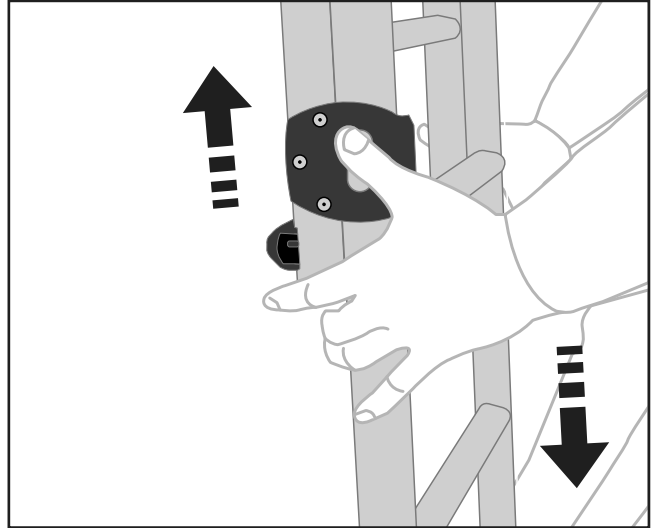
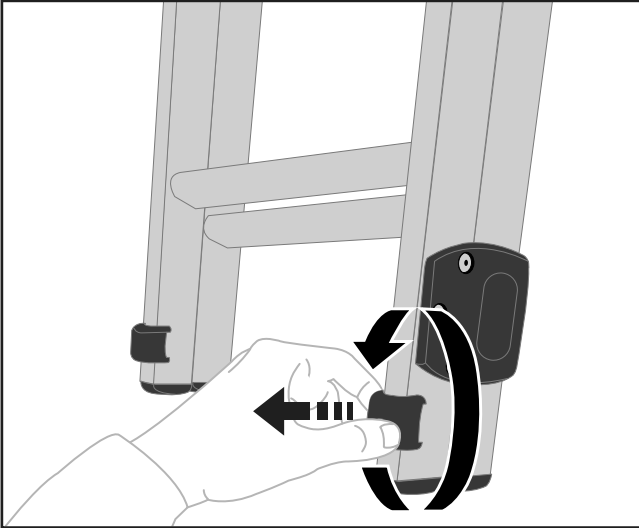

  
LOCK

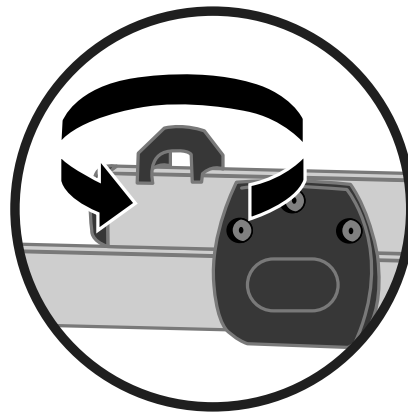

  
UNLOCK

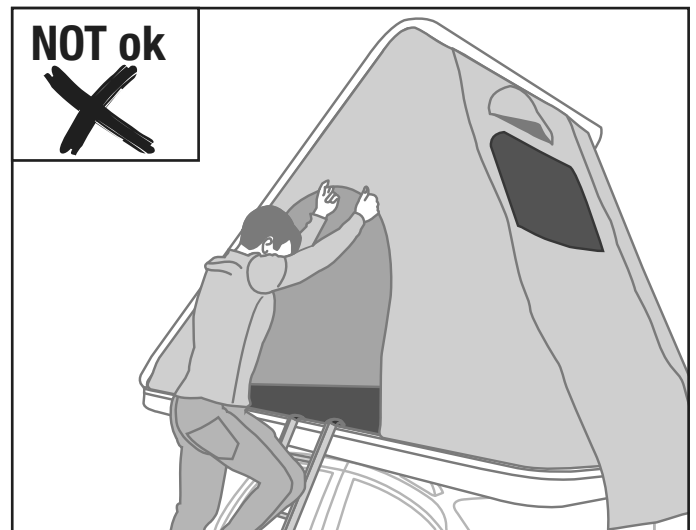
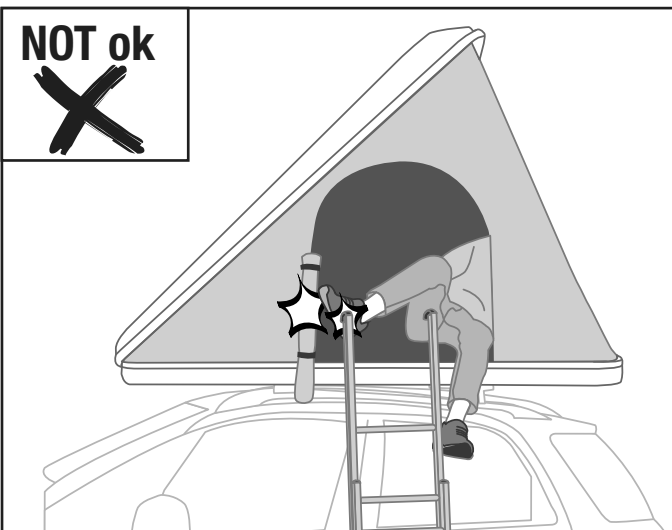
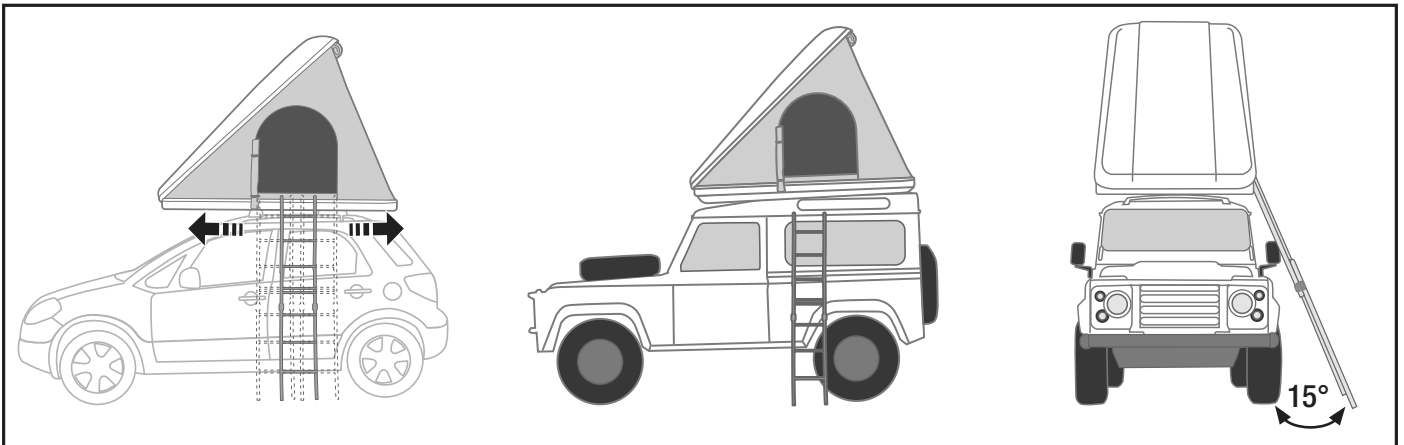
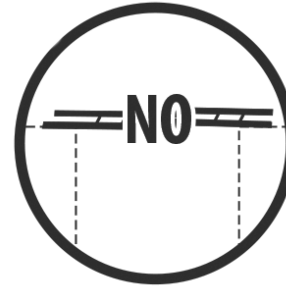
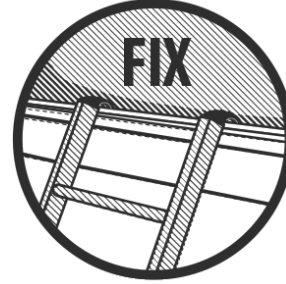

11

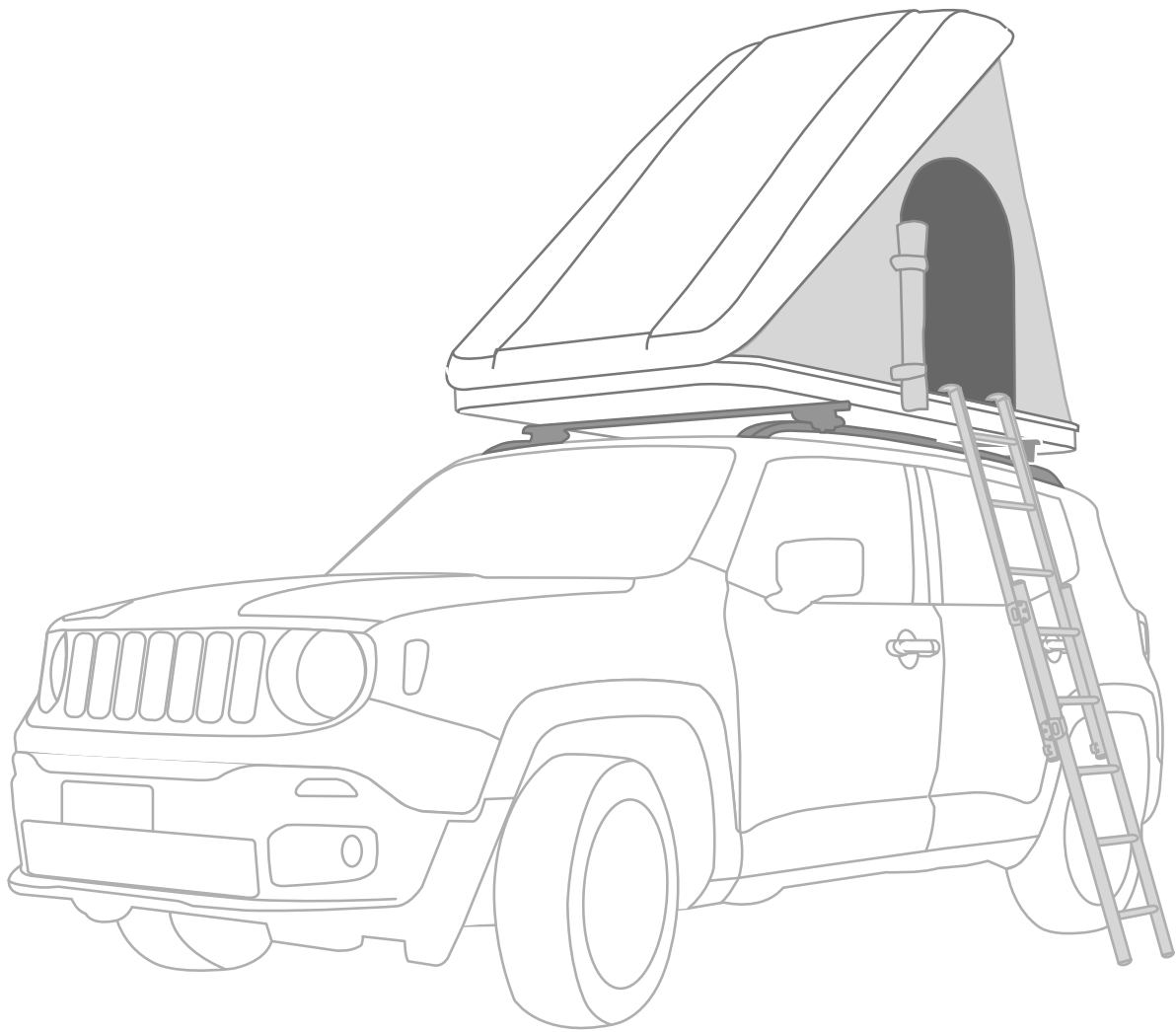
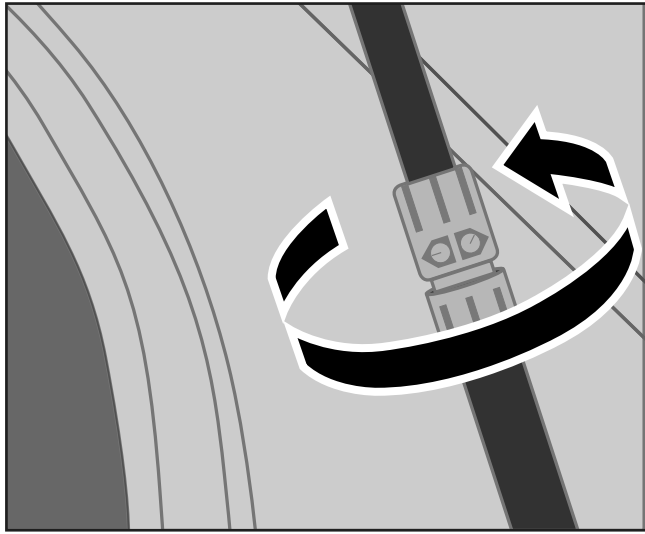

# CLOSING

Chiusura • Fermeture • Schließung

12

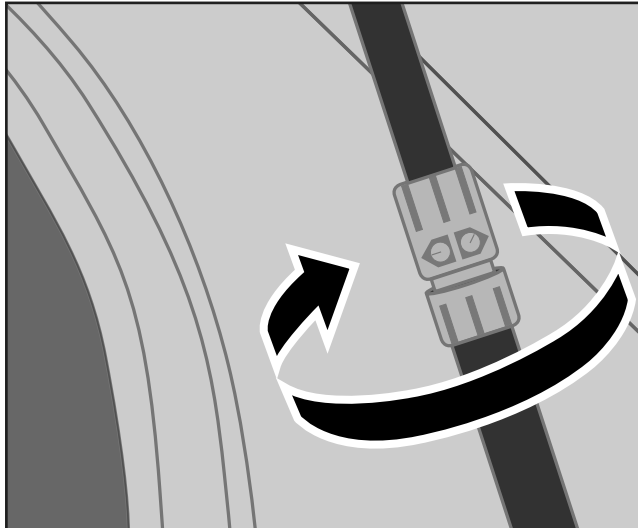

13

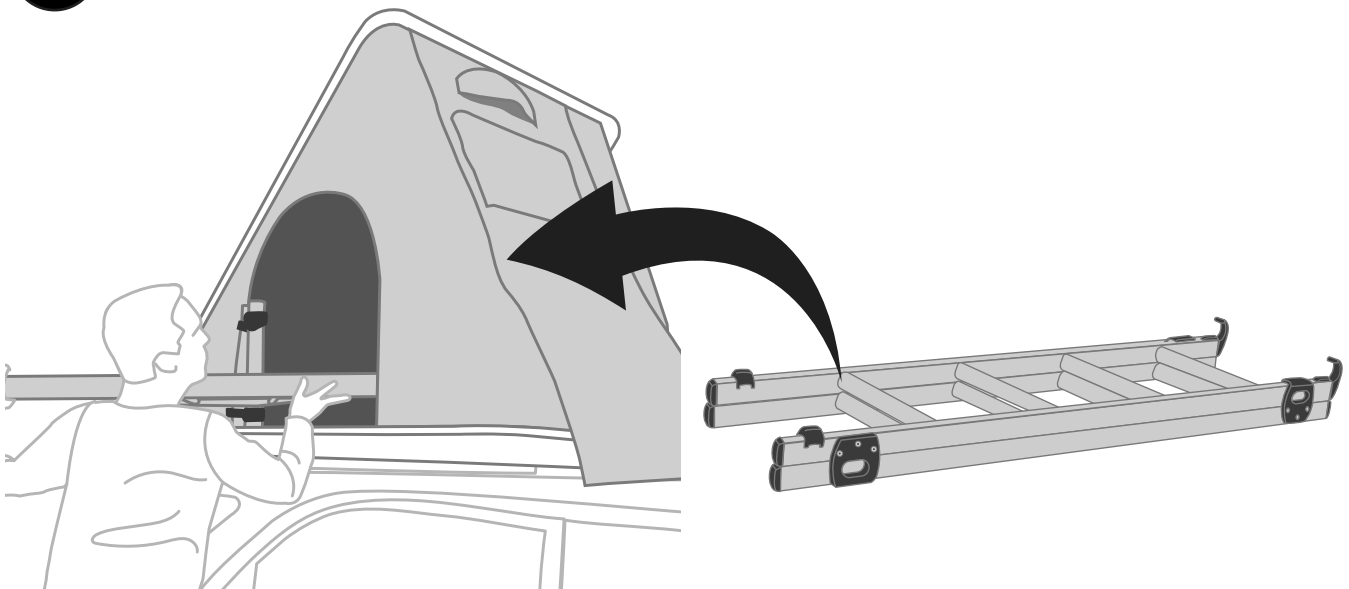

	COLUMBUS SMALL	COLUMBUS MEDIUM	COLUMBUS LARGE	COLUMBUS SMALL EXTRA LONG	COLUMBUS MEDIUM EXTRA LONG
Standard ladder	✓ ok	✓ ok	✓ ok	✓ ok	✓ ok
Ladder 4X4	X NOT ok	X NOT ok	X NOT ok	✓ ok	✓ ok
Extra Long ladder	X NOT ok	X NOT ok	X NOT ok	✓ ok	✓ ok

ok  
✓

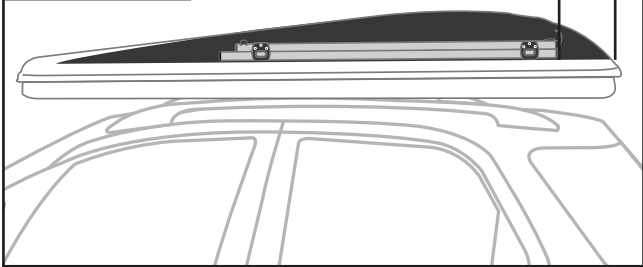

NOT ok  
✗

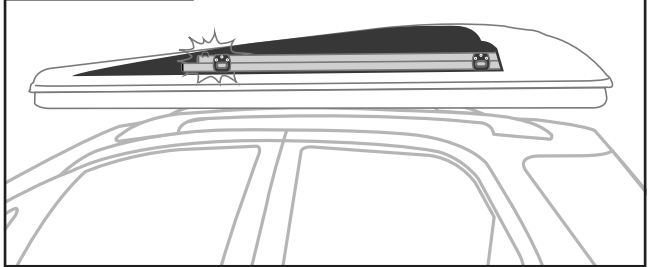

14

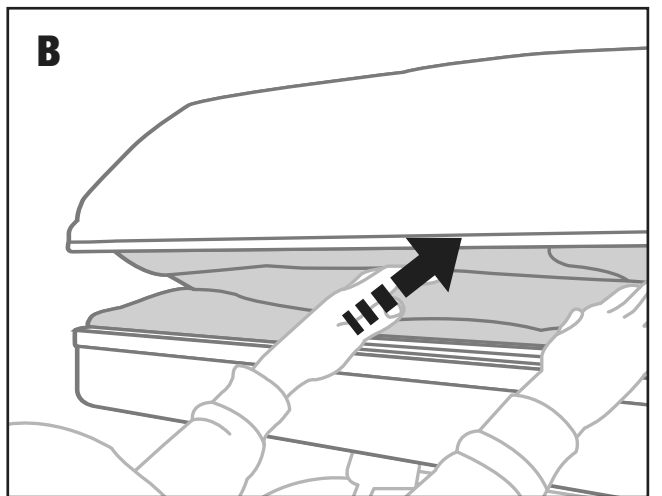
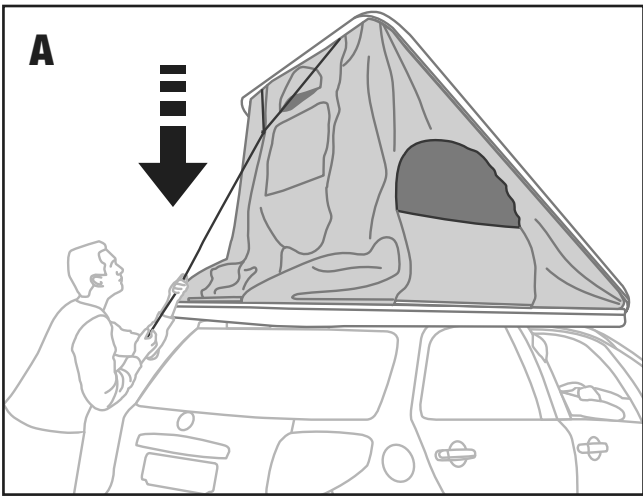

ok  
✓

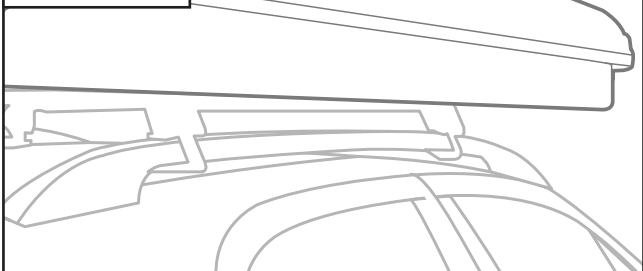

NOT ok  
✗

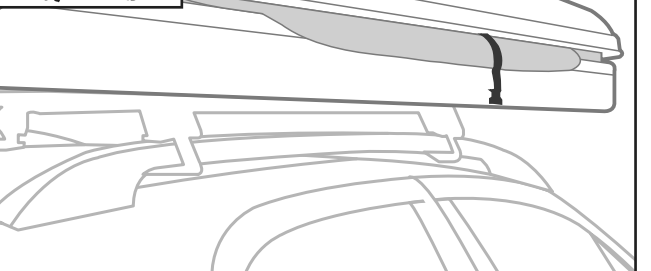



15

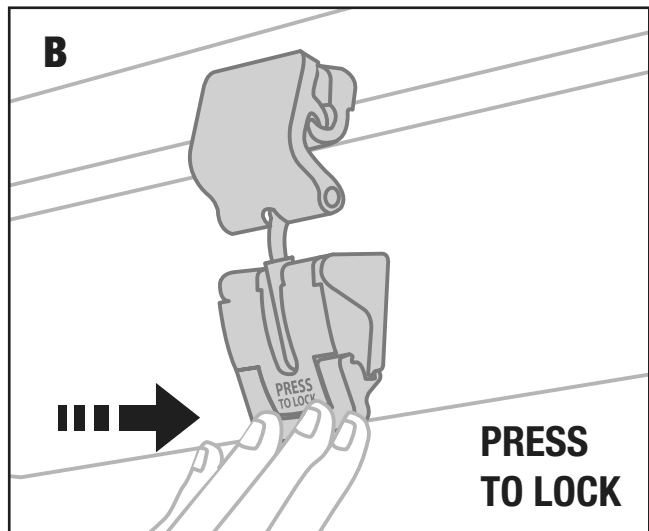
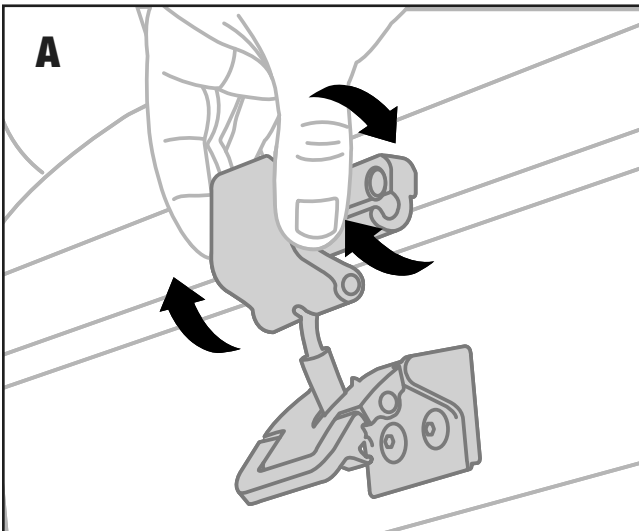
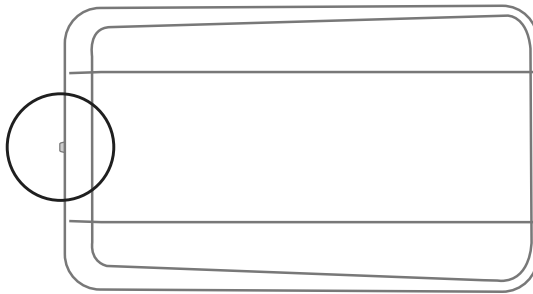

16

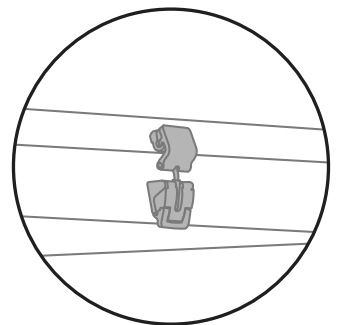
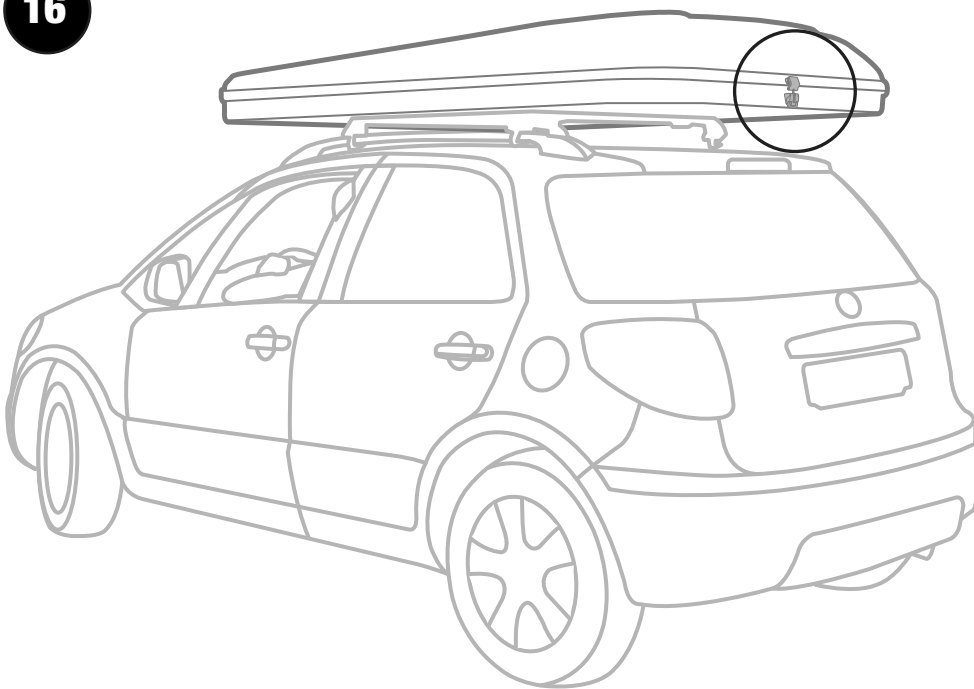

# AWNING (FOR COLUMBUS VARIANT)

Tendalino • Bâche • Sonnensegel

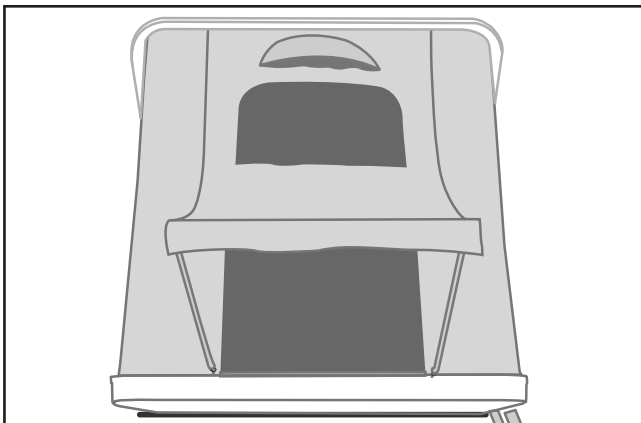
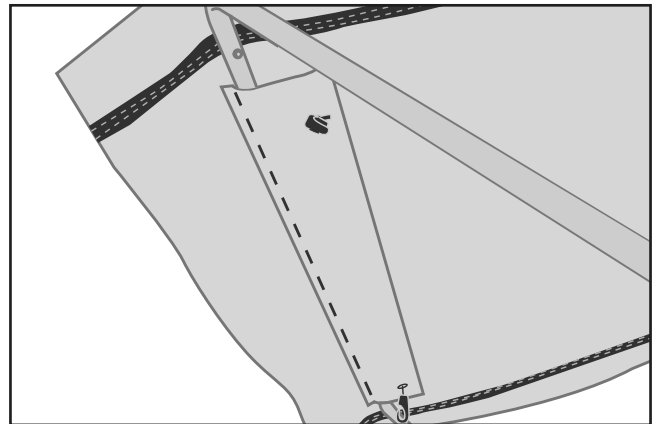
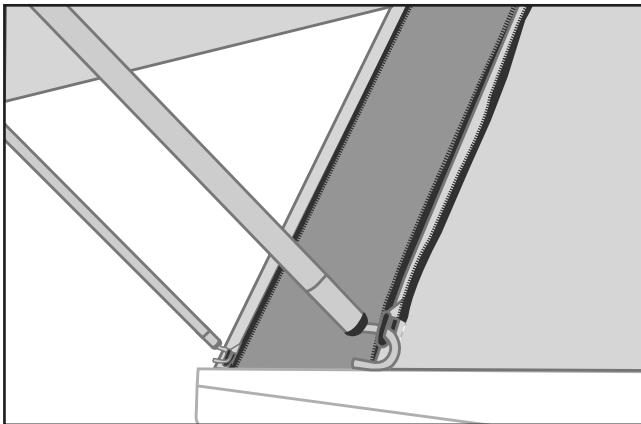

# LAMP

Lampada • Lampe • Lampe

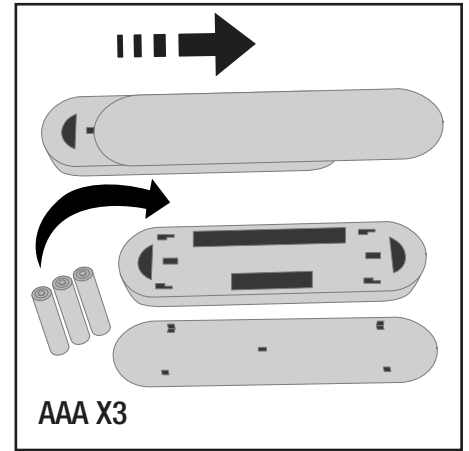
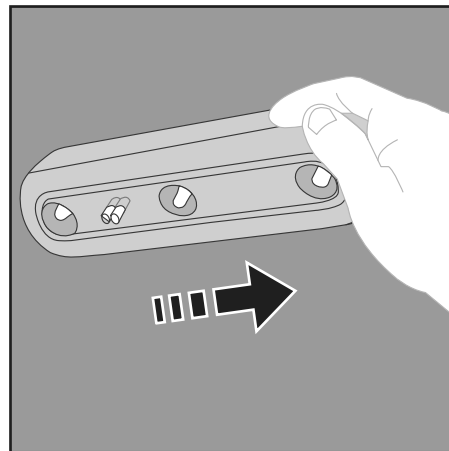
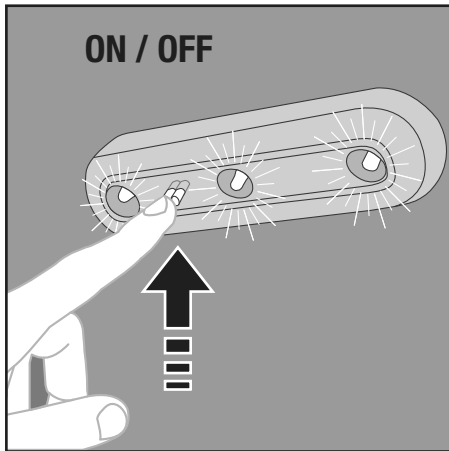

# HANDLE WITH CARE

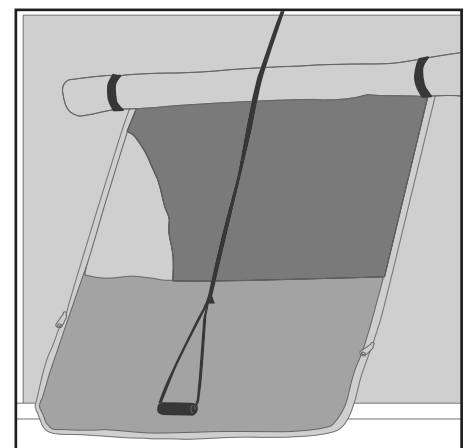
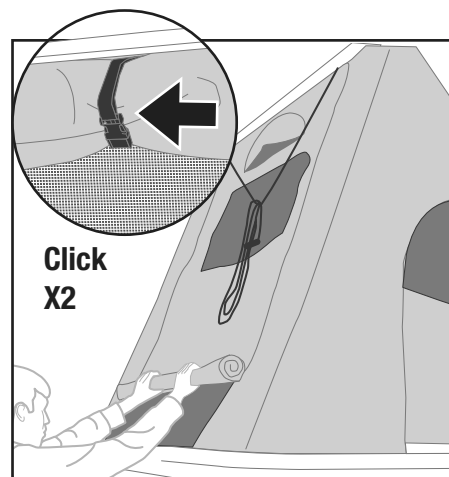
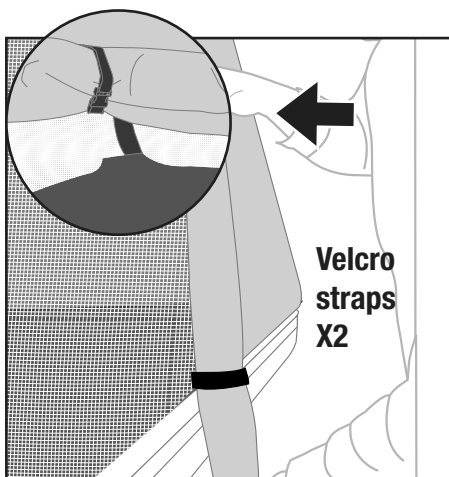
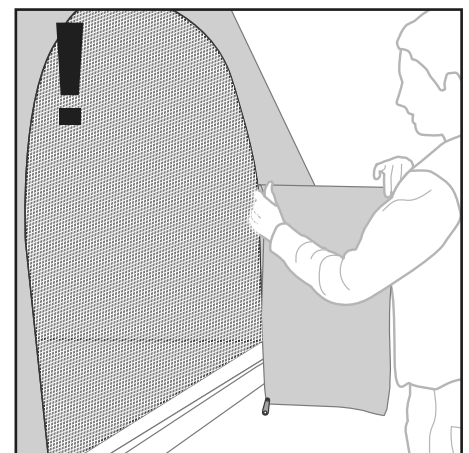
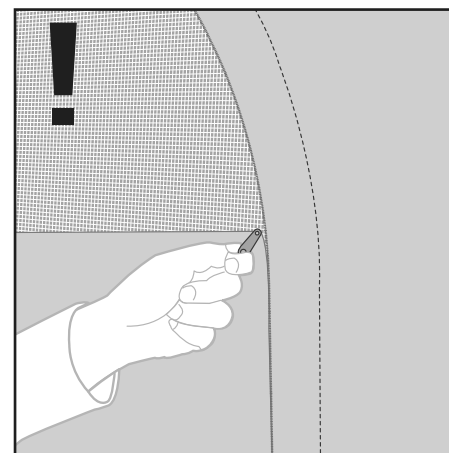
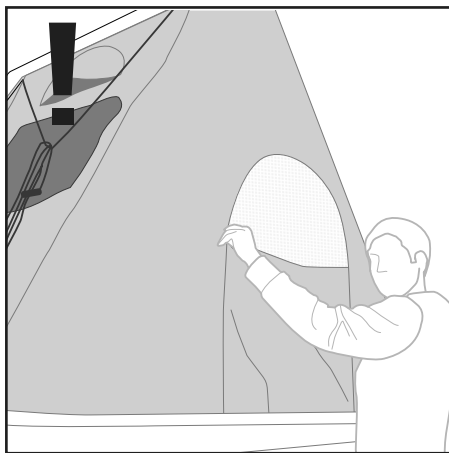

# WARNINGS

Avvertenze • Avertissement • Warnungen

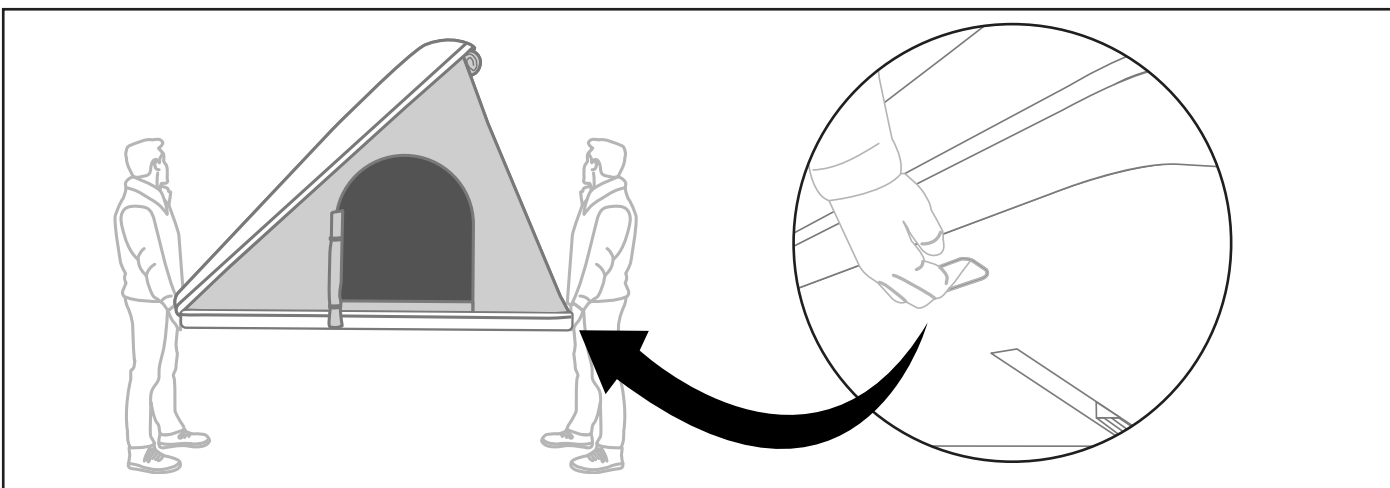
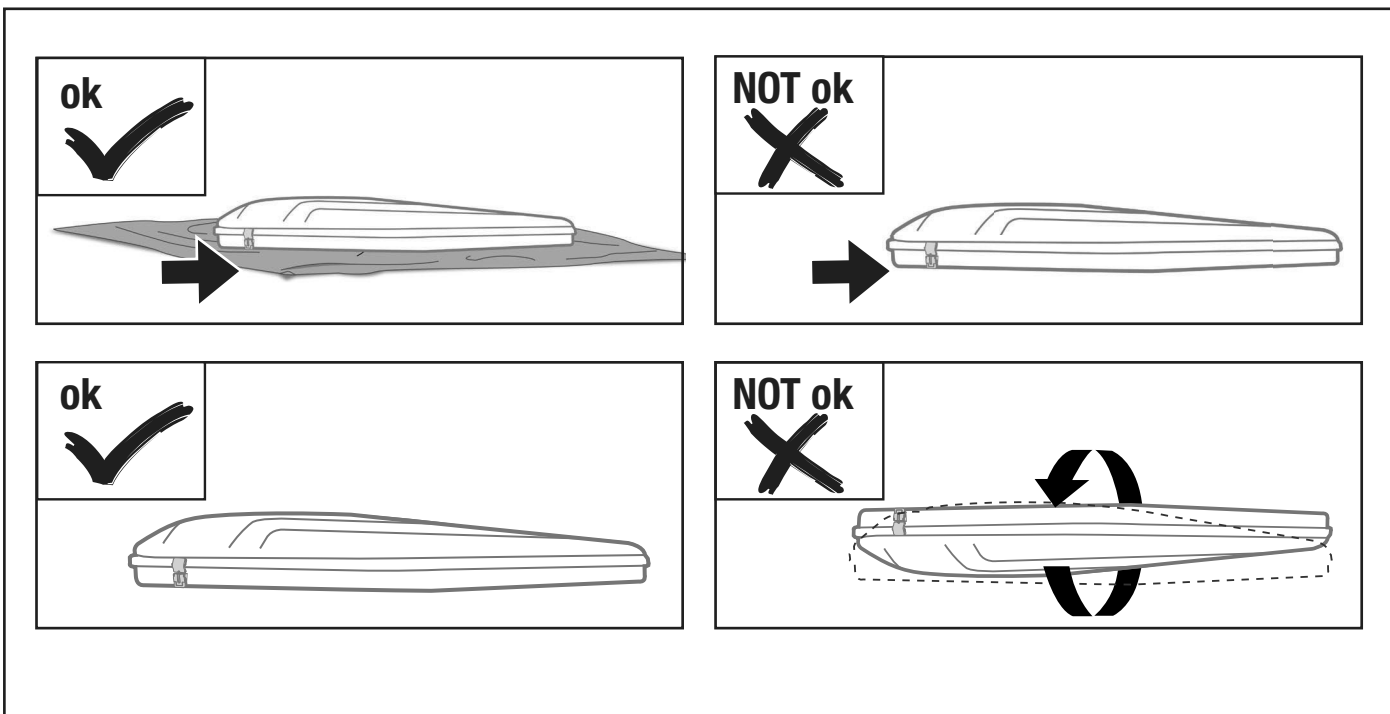
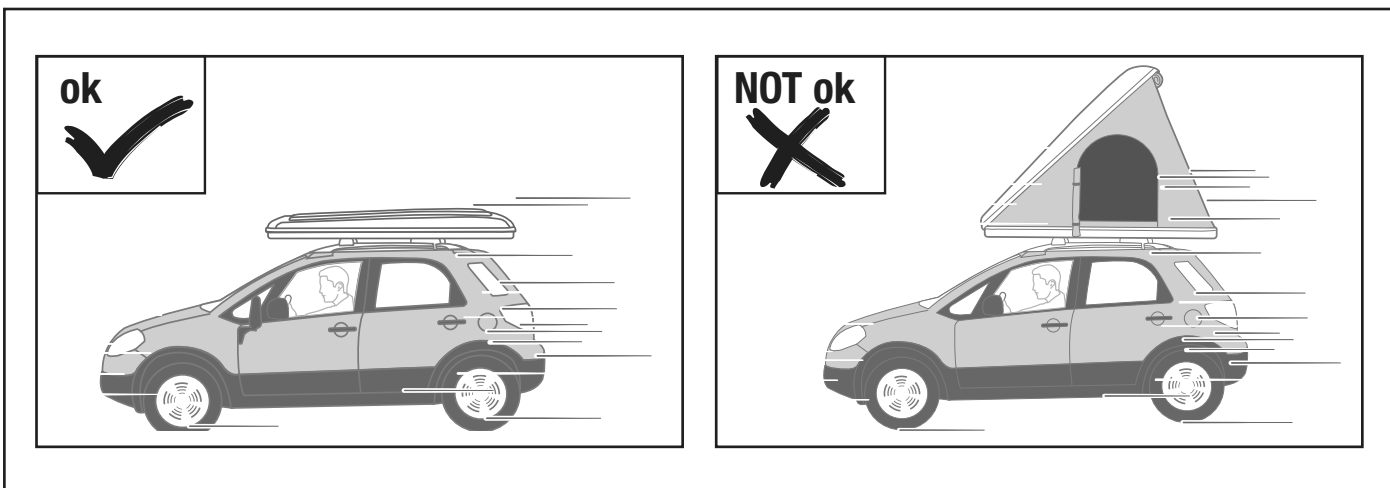

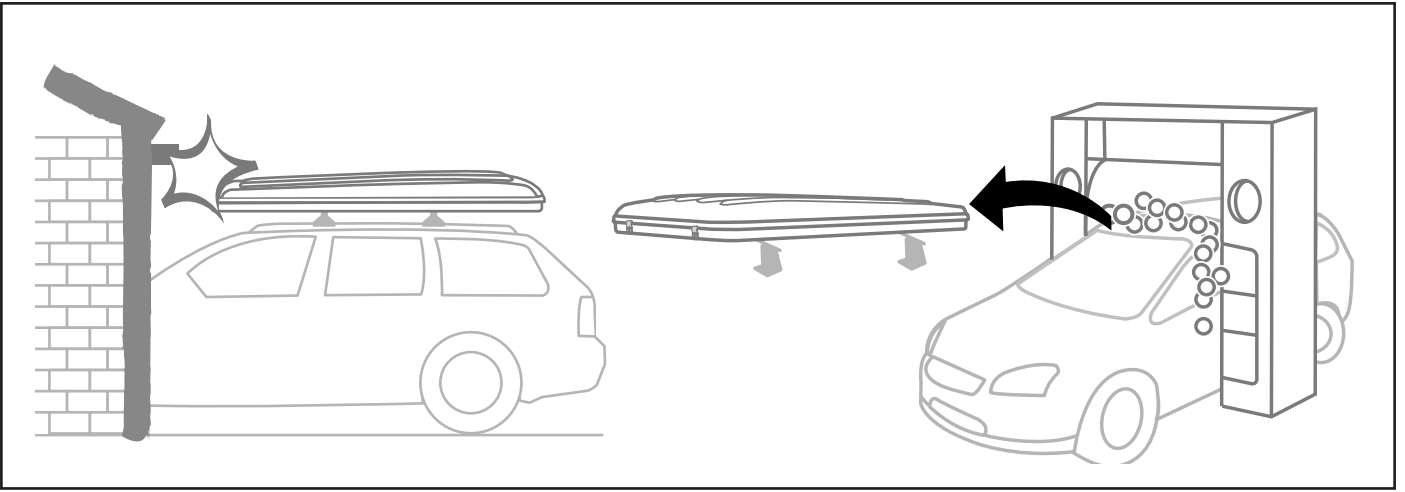









**AUTOHOME**® produced by  
Zifer Italia Srl  
Viale Risorgimento, 23  
46017 Rivarolo Mantovano  
(Mantova) Italy  
Tel. +39 0376 99590  
+39 0376 958164  
Fax +39 0376 958088

**AUTOHOME-OFFICIAL.COM**  
info@autohome.it

 MADE IN ITALY

 Autohome Official-Page

 autohome\_official



PRODUCT QUALITY CERTIFICATION